



REVOLUTION

Revolution®

design by Luca Papini

REVOLUTION®

Un nuovo sanitario e un bidet in Livin-Stone®.

Una trasformazione radicale.

Il capovolgimento di un ordine.

Le rivoluzioni, coraggiosamente, segnano un nuovo punto di partenza, questo è quello che Esedra ha voluto iniziare all'interno del mondo del bagno.

## LIVIN-STONE® solid surface

Derivato dalla selezione di materie prime di primissima qualità, componente principale è una carica minerale naturale denominata, tri-idrato di alluminio (ATH), minerale derivato dalla Bauxite, legata da una bassa percentuale di materia "acrilata" che le conferisce malleabilità e lavorabilità) è un materiale studiato per soddisfare i più alti standard di qualità tecnologia e impatto ambientale, è:

VERSATILE: è un materiale ad alte prestazioni funzionali ed estetiche.

RAFFINATO: la superficie è solida (solid surface) omogenea, non porosa ed estremamente liscia. Oltre a trasmettere senso estetico e di purezza, è facile da pulire, non ingiallisce e il colore non perde tono nel tempo.

PREGIATO: è completamente atossico, antibatterico, inerte, ipoallergenico, ignifugo. E inoltre si può facilmente ripristinare, e riciclare rientrando così tra quei materiali definiti "eco-compatibili".

Derived from the selection of highest quality raw materials, the main component is a natural mineral filler called, aluminum tri-hydrate (ATH) derived from bauxite ore, linked by a low percentage of matter "acrylics" that gives malleability and workability it is a material designed to meet the highest standards of quality technology and environmental impact, is:

VERSATILE: it is a material with high functional and aesthetic performance.

REFINED: the surface is solid (solid surface) homogeneous, non-porous and extremely smooth. Besides delivering aesthetic sense and purity, it is easy to clean, over time does not become yellow and does not lose the color tone.

QUALITY: is completely non-toxic, antibacterial, inert, hypoallergenic, flame retardant. And also you can easily recover, recycle and thus being part of those materials defined "environmentally friendly".

### CURA E MANUTENZIONE:

MANUTENZIONE QUOTIDIANA: si consiglia di pulire la superficie con detergente anticalcare liquido (Vical®, Ajax®, Cif®) utilizzando una spugna morbida.

### CARE AND MAINTENANCE:

DAILY MAINTENANCE: we recommend cleaning the surface with liquid softener detergent (Vical®, Ajax®, Cif®) using a soft sponge.

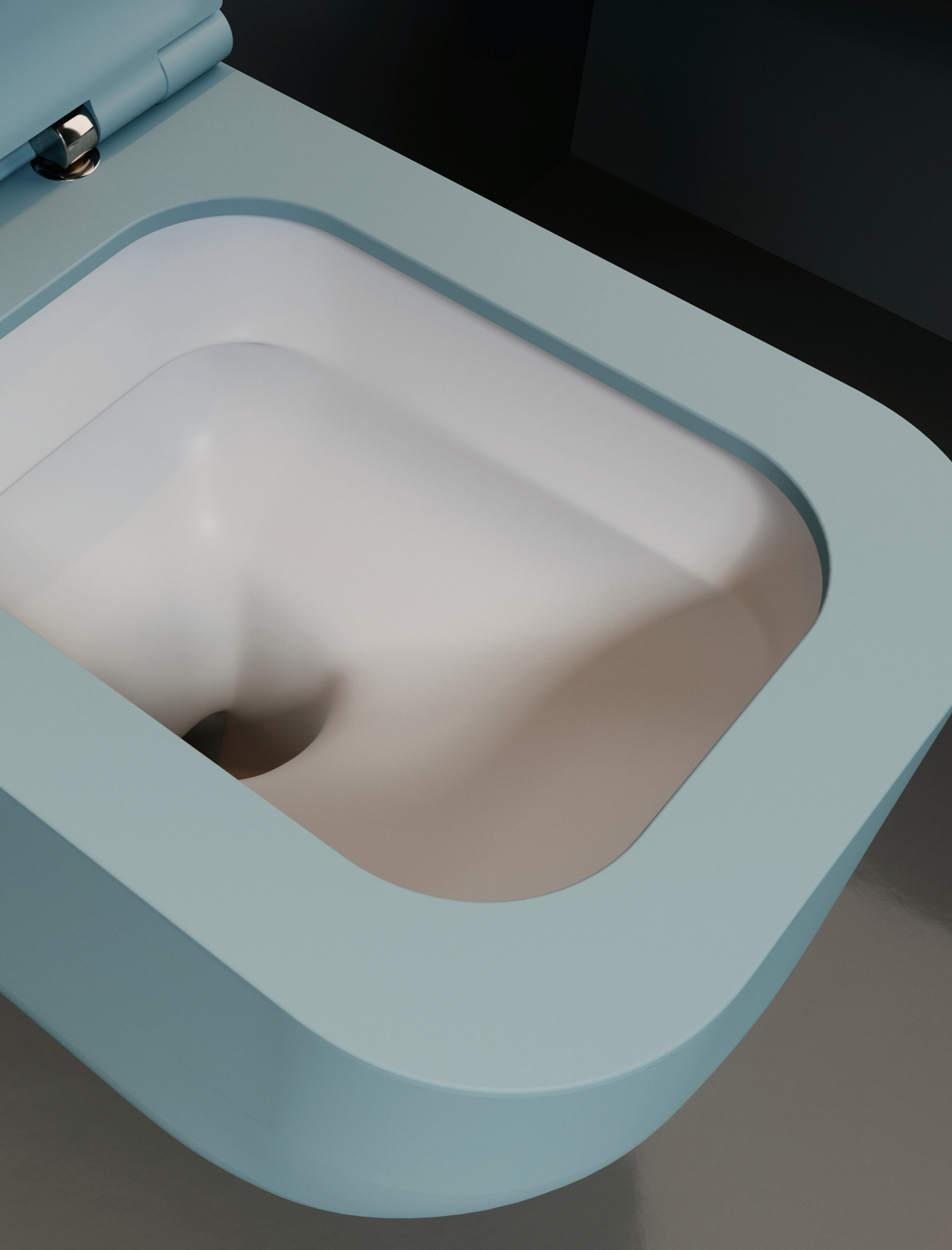

## Perchè REVOLUTION®



- DESIGN** Spessori, angoli e linee unici  
Superfici perfette senza irregolarità  
Pulizia delle forme  
*Sharpness, corners and unique lines  
Perfect and regular surfaces  
Cleaning of the shapes*
- IGIENE** Revolution® è prodotto in Livin-Stone® materiale antibatterico che assicura un'igiene mai raggiunta prima  
*Revolution® is made in Livin-Stone® antibacterial material which ensures hygiene never reached before*
- GREEN** Revolution® è ECO SOSTENIBILE. Il 75% del materiale del vaso e il 100% del materiale del bidet è riciclabile. Per produrre il vaso si risparmia il 70% di energia combustibile con relative emissioni in atmosfera in tema con il RISPETTO AMBIENTALE.  
*Revolution® is ECO FRIENDLY. 75% of the material of the pan and 100% of the material of the bidet is recyclable. 70% of energy is saved to produce the pan and also the related emissions into atmosphere to respect the environment.*
- RESISTENZA** Revolution® ha superato tutti i test tecnici di resistenza meccanica. Garantisce quindi la stessa affidabilità dei prodotti tradizionali.  
*Revolution® has passed all the technical tests of mechanic resistance. Therefore guarantees the same reliability of the traditional products.*
- COLORE** Revolution® è un prodotto tutta pasta declinabile in diverse colorazioni.  
*Revolution® is produced in full body and available in different colors.*
- BREVETTO** L'idea innovativa di Revolution® è coperta da Brevetto ( Patent Pending ) questo non consente tentativi di copie e cloni.  
*The innovative idea of Revolution® is covered by a patent (Patent Pending), this does not allow attempts at copies and clones*

cotone





VASO SOSPESO REVOLUTION COTONE / REVOLUTION COTONE WALL HUNG WC  
SEDILE SLIM SOFT CLOSE REVOLUTION COTONE / REVOLUTION COTONE SLIM SOFT CLOSE SEAT COVER  
BIDET SOSPESO REVOLUTION COTONE / REVOLUTION COTONE WALL HUNG BIDET

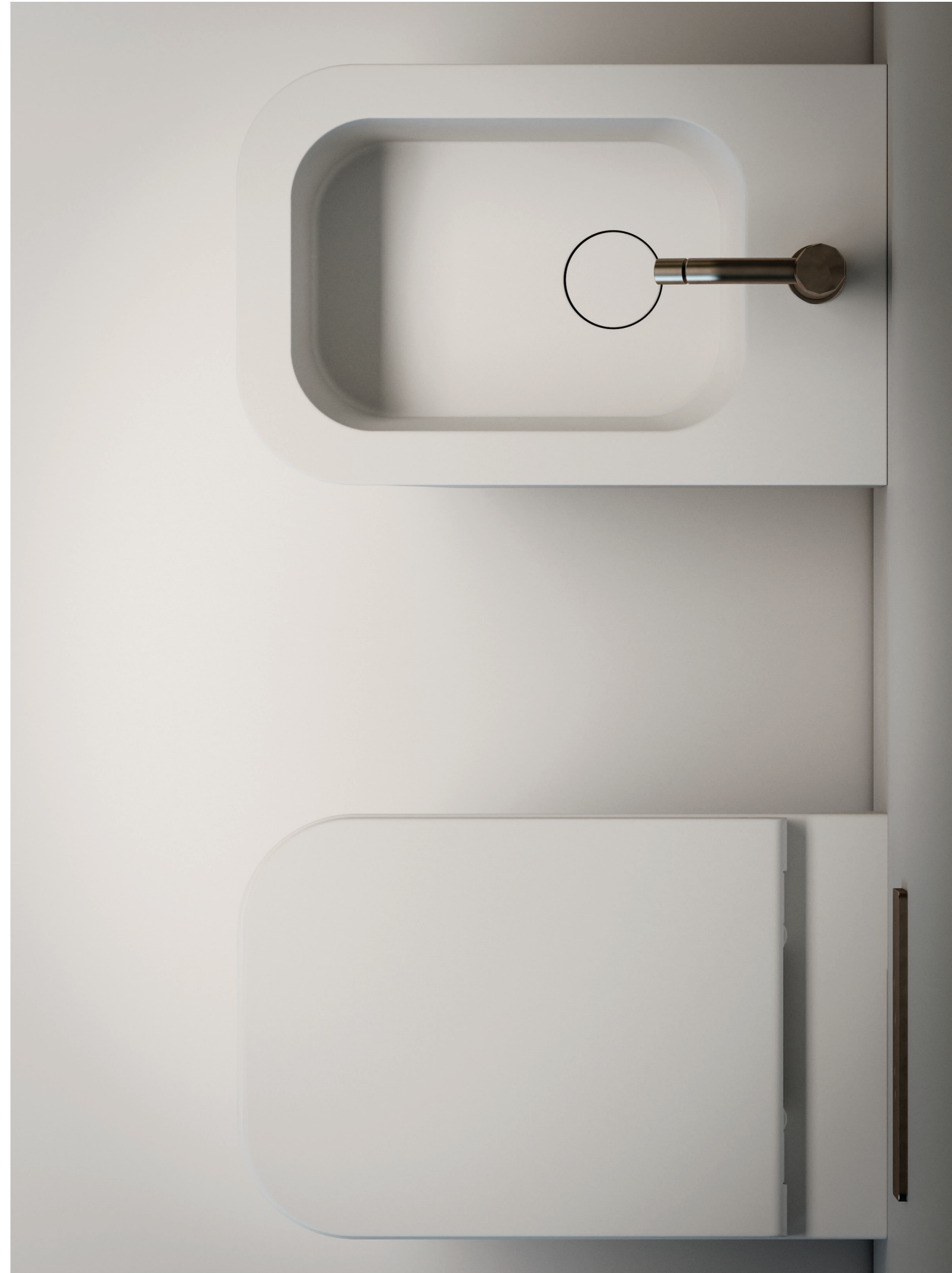



LAVABO FLAT 7 COTONE / FLAT 7 WASHBASIN COTONE

LAVABO QUBE 10 COTONE / QUBE 10 WASHBASIN COTONE



CONSOLLE 95 IN CERAMICA REVOLUTION COTONE / CERAMIC CONSOLE 95 REVOLUTION COTONE  
STRUTTURA PORTANTE CON 2 CASSETTI COTONE / FREE STANDING COTONE CABINET WITH 2 DRAWERS



camelia





VASO SOSPESO REVOLUTION CAMELIA / REVOLUTION CAMELIA WALL HUNG WC  
SEDILE SLIM SOFT CLOSE REVOLUTION CAMELIA / REVOLUTION CAMELIA SLIM SOFT CLOSE SEAT COVER  
BIDET SOSPESO REVOLUTION CAMELIA / REVOLUTION CAMELIA WALL HUNG BIDET





CONSOLLE 95 IN CERAMICA REVOLUTION COTONE / CERAMIC CONSOLE 95 REVOLUTION COTONE  
STRUTTURA PORTANTE CON 2 CASSETTI CAMELIA / FREE STANDING CAMELIA CABINET WITH 2 DRAWERS



LAVABO QUBE 10 CAMELIA / QUBE 10 WASHBASIN CAMELIA



aloe



VASO SOSPESO REVOLUTION ALOE / REVOLUTION ALOE WALL HUNG WC  
SEDILE SLIM SOFT CLOSE REVOLUTION ALOE / REVOLUTION ALOE SLIM SOFT CLOSE SEAT COVER  
BIDET SOSPESO REVOLUTION ALOE / REVOLUTION ALOE WALL HUNG BIDET







CONSOLLE 95 IN CERAMICA REVOLUTION COTONE / CERAMIC CONSOLE 95 REVOLUTION COTONE  
STRUTTURA PORTANTE CON 2 CASSETTI ALOE / FREE STANDING ALOE CABINET WITH 2 DRAWERS



LAVABO QUBE 8 ALOE / QUBE 8 WASHBASIN ALOE

LAVABO QUBE 9 ALOE / QUBE 9 WASHBASIN ALOE







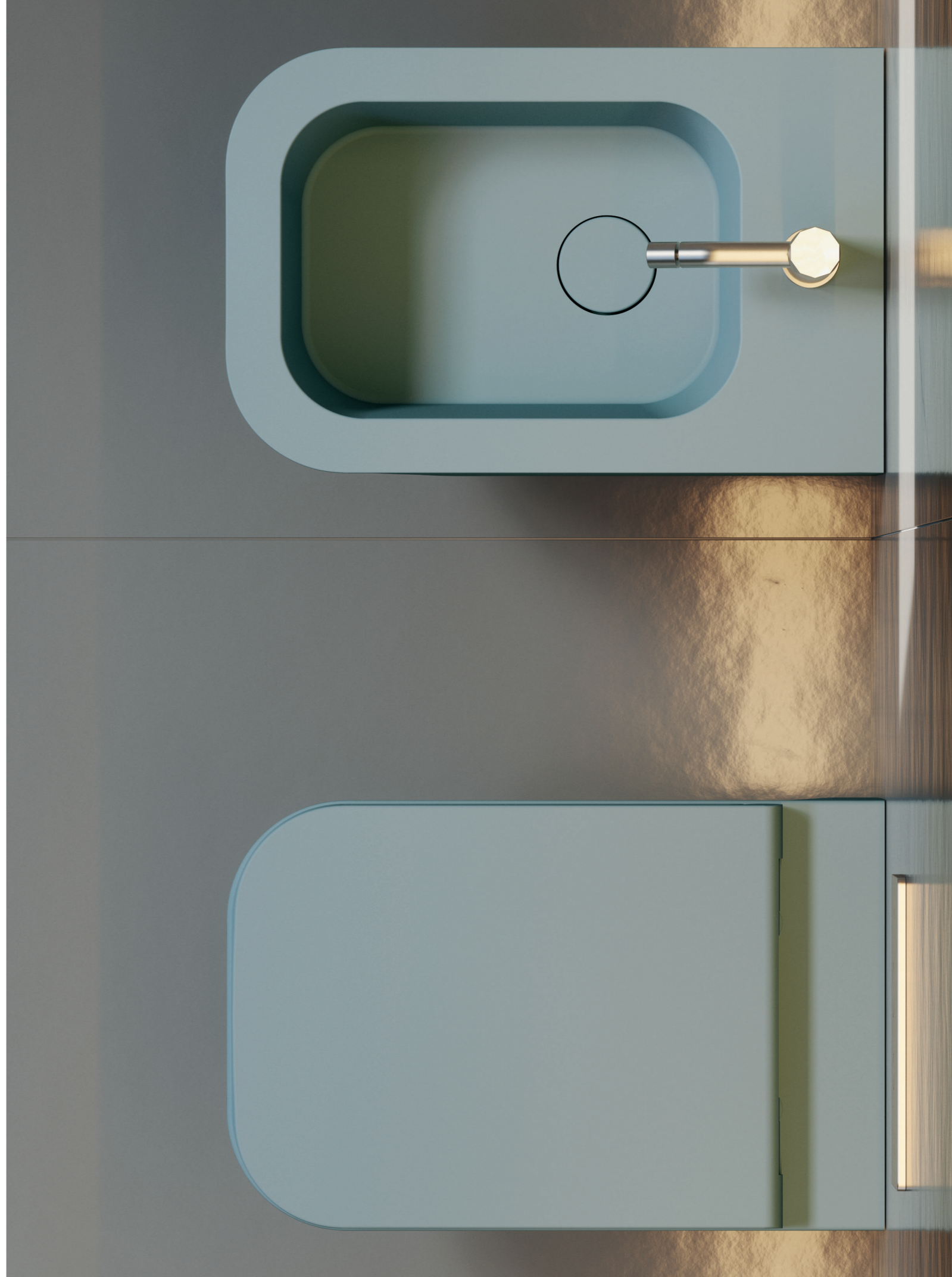

VASO SOSPESO REVOLUTION AVIO / REVOLUTION AVIO WALL HUNG WC  
SEDILE SLIM SOFT CLOSE REVOLUTION AVIO / REVOLUTION AVIO SLIM SOFT CLOSE SEAT COVER  
BIDET SOSPESO REVOLUTION AVIO / REVOLUTION AVIO WALL HUNG BIDET



LAVABO FLAT 8 AVIO / FLAT 8 WASHBASIN AVIO

LAVABO FLAT 9 AVIO / FLAT 9 WASHBASIN AVIO



CONSOLLE 95 IN CERAMICA REVOLUTION COTONE / CERAMIC CONSOLE 95 REVOLUTION COTONE  
STRUTTURA PORTANTE CON 2 CASSETTI AVIO / FREE STANDING AVIO CABINET WITH 2 DRAWERS

listino

I prezzi del seguente listino si intendono IVA esclusa

# Cotone



VASO SOSPESO COTONE  
COTONE WALL HUNG WC  
COD. 1.WCSR € 899,00

SEDILE SLIM SOFT CLOSE COTONE  
SLIM COTONE SOFT CLOSE SEAT COVER  
COD. 1.CWR € 177,00



BIDET SOSPESO COTONE  
COTONE WALL HUNG BIDET  
COD. 1.BDSR € 840,00

PILETTA PER BIDET  
PLUG FOR BIDET  
COD. 1.CWR € 59,00



LAVABO QUBE 9 COTONE  
COTONE WASHBASIN QUBE 9  
COD. 1.LVQ 9 € 399,00

PILETTA PER LAVABO  
PLUG FOR WASHBASIN  
COD. 1.PLR € 59,00



CONSOLLE IN CERAMICA COTONE  
COTONE CERAMIC WASHBASIN  
COD. 1.LVR € 599,00

PILETTA CERAMICA PER LAVABO COTONE  
CERAMIC PLUG FOR WASHBASIN COTONE  
COD. 1.PIL € 63,00

STRUTTURA PORTANTE 300X490XH300 CON 2 CASSETTI  
COTONE, COMPLETO DI STAFFE DI FISSAGGIO.  
FREE STANDING CABINET 300X490XH300 WITH 2 DRAWERS,  
FIXING KIT INCLUDED.  
COD. 1.CAR € 399,00



LAVABO FLAT 7 REVOLUTION COTONE  
COTONE WASHBASIN FLAT 7  
COD. 1.LVF 7 € 319,00

PILETTA PER LAVABO  
PLUG FOR WASHBASIN  
COD. 1.PLR € 59,00



LAVABO FLAT 9 REVOLUTION COTONE  
COTONE WASHBASIN FLAT 9  
COD. 1.LVF 9 € 549,00

PILETTA PER LAVABO  
PLUG FOR WASHBASIN  
COD. 1.PLR € 59,00



LAVABO FLAT 8 COTONE  
COTONE WASHBASIN FLAT 8  
COD. 1.LVF 8 € 399,00

PILETTA PER LAVABO  
PLUG FOR WASHBASIN  
COD. 1.PLR € 59,00



LAVABO QUBE 10 COTONE  
COTONE WASHBASIN QUBE 10  
COD. 1.LVQ 10 € 549,00

PILETTA PER LAVABO  
PLUG FOR WASHBASIN  
COD. 1.PLR € 59,00



LAVABO QUBE 8 COTONE  
COTONE WASHBASIN QUBE 8  
COD. 1.LVQ 8 € 1.999,00

PILETTA PER LAVABO  
PLUG FOR WASHBASIN  
COD. 1.PLR € 59,00



VASCA COTONE  
COTONE WASHBASIN QUBE 8  
COD. 1.VR € 3.900,00

PILETTA PER VASCA  
PLUG FOR BATHTUB  
COD. 1.PVR € 99,00

# Camelia

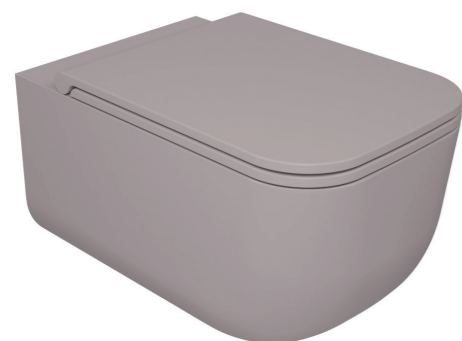

VASO SOSPESO CAMELIA  
CAMELIA WALL HUNG WC  
COD. 2.WCSR € 899,00

SEDILE SLIM SOFT CLOSE CAMELIA  
SLIM CAMELIA SOFT CLOSE SEAT COVER  
COD. 2.CWR € 177,00



BIDET SOSPESO CAMELIA  
CAMELIA WALL HUNG BIDET  
COD. 2.BDSR € 840,00

PILETTA PER BIDET  
PLUG FOR BIDET  
COD. 2.CWR € 59,00



LAVABO QUBE 9 CAMELIA  
CAMELIA WASHBASIN QUBE 9  
COD. 2.LVQ 9 € 499,00

PILETTA PER LAVABO  
PLUG FOR WASHBASIN  
COD. 2.PLR € 59,00



CONSOLLE IN CERAMICA COTONE  
COTONE CERAMIC WASHBASIN  
COD. 1.LVR € 599,00

PILETTA CERAMICA PER LAVABO COTONE  
CERAMIC PLUG FOR WASHBASIN COTONE  
COD. 1.PIL € 63,00

STRUTTURA PORTANTE 300X490XH300 CON 2 CASSETTI  
CAMELIA, COMPLETO DI STAFFE DI FISSAGGIO.  
FREE STANDING CABINET 300X490XH300 WITH 2 DRAWERS,  
FIXING KIT INCLUDED.  
COD. 2.CAR € 399,00



LAVABO FLAT 7 CAMELIA  
CAMELIA WASHBASIN FLAT 7  
COD. 2.LVF 7 € 399,00

PILETTA PER LAVABO  
PLUG FOR WASHBASIN  
COD. 2.PLR € 59,00



LAVABO FLAT 9 CAMELIA  
CAMELIA WASHBASIN FLAT 9  
COD. 2.LVF 9 € 669,00

PILETTA PER LAVABO  
PLUG FOR WASHBASIN  
COD. 2.PLR € 59,00



LAVABO FLAT 8 CAMELIA  
CAMELIA WASHBASIN FLAT 8  
COD. 2.LVF 8 € 499,00

PILETTA PER LAVABO  
PLUG FOR WASHBASIN  
COD. 2.PLR € 59,00



LAVABO QUBE 10 CAMELIA  
CAMELIA WASHBASIN QUBE 10  
COD. 2.LVQ 10 € 659,00

PILETTA PER LAVABO  
PLUG FOR WASHBASIN  
COD. 2.PLR € 59,00



LAVABO QUBE 8 CAMELIA  
CAMELIA WASHBASIN QUBE 8  
COD. 2.LVQ 8 € 2.299,00

PILETTA PER LAVABO  
PLUG FOR WASHBASIN  
COD. 2.PLR € 59,00



VASCA CAMELIA  
CAMELIA WASHBASIN QUBE 8  
COD. 2.VR € 5.500,00

PILETTA PER VASCA  
PLUG FOR BATHTUB  
COD. 2.PVR € 99,00



# Aloe

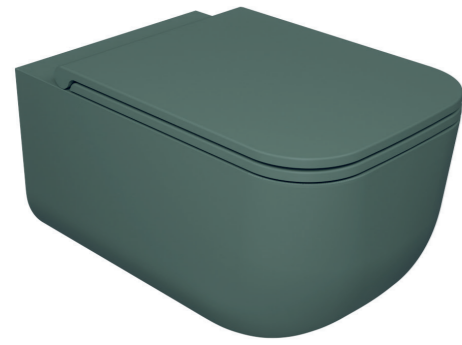

VASO SOSPESO ALOE  
ALOE WALL HUNG WC  
COD. 3.WCSR € 899,00

SEDILE SLIM SOFT CLOSE ALOE  
SLIM ALOE SOFT CLOSE SEAT COVER  
COD. 3.CWR € 177,00



BIDET SOSPESO ALOE  
ALOE WALL HUNG BIDET  
COD. 3.BDSR € 840,00

PILETTA PER BIDET  
PLUG FOR BIDET  
COD. 3.CWR € 59,00



LAVABO QUBE 9 ALOE  
ALOE WASHBASIN QUBE 9  
COD. 3.LVQ 9 € 499,00

PILETTA PER LAVABO  
PLUG FOR WASHBASIN  
COD. 3.PLR € 59,00



CONSOLLE IN CERAMICA COTONE  
ALOE CERAMIC WASHBASIN  
COD. 1.LVR € 599,00

PILETTA CERAMICA PER LAVABO COTONE  
CERAMIC PLUG FOR WASHBASIN COTONE  
COD. 1.PIL € 63,00

STRUTTURA PORTANTE 300X490XH300 CON 2 CASSETTI ALOE,  
COMPLETO DI STAFFE DI FISSAGGIO.  
FREE STANDING CABINET 300X490XH300 WITH 2 DRAWERS,  
FIXING KIT INCLUDED.  
COD. 3.CAR € 399,00

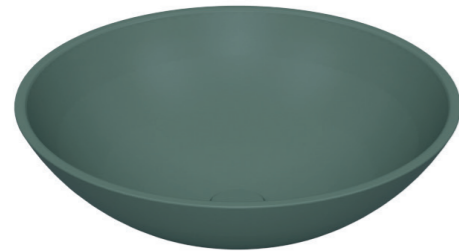

LAVABO FLAT 7 ALOE  
ALOE WASHBASIN FLAT 7  
COD. 3.LVF 7 € 399,00

PILETTA PER LAVABO  
PLUG FOR WASHBASIN  
COD. 3.PLR € 59,00

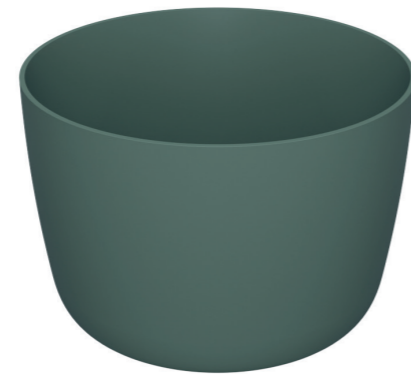

LAVABO FLAT 9 ALOE  
ALOE WASHBASIN FLAT 9  
COD. 3.LVF 9 € 669,00

PILETTA PER LAVABO  
PLUG FOR WASHBASIN  
COD. 3.PLR € 59,00



LAVABO FLAT 8 ALOE  
ALOE WASHBASIN FLAT 8  
COD. 3.LVF 8 € 499,00

PILETTA PER LAVABO  
PLUG FOR WASHBASIN  
COD. 3.PLR € 59,00

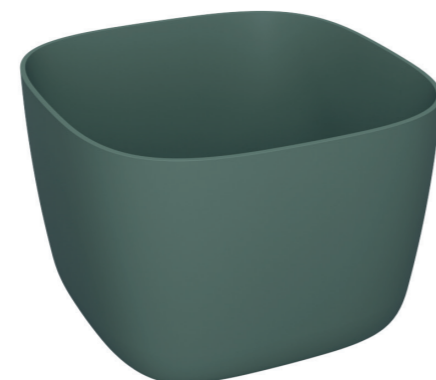

LAVABO QUBE 10 ALOE  
ALOE WASHBASIN QUBE 10  
COD. 3.LVQ 10 € 659,00

PILETTA PER LAVABO  
PLUG FOR WASHBASIN  
COD. 3.PLR € 59,00



LAVABO QUBE 8 ALOE  
ALOE WASHBASIN QUBE 8  
COD. 3.LVQ 8 € 2.299,00

PILETTA PER LAVABO  
PLUG FOR WASHBASIN  
COD. 3.PLR € 59,00

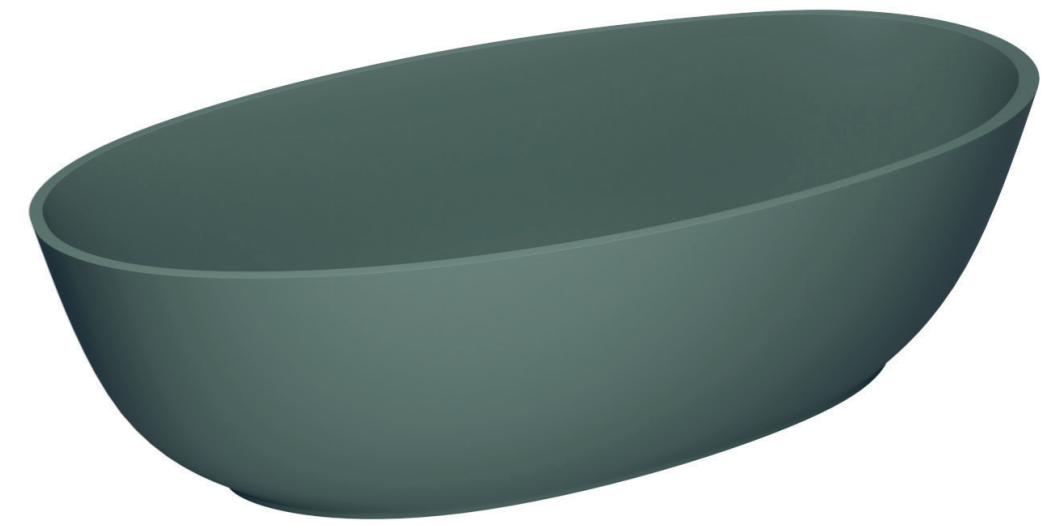

VASCA ALOE  
ALOE WASHBASIN QUBE 8  
COD. 3.VR € 5.500,00

PILETTA PER VASCA  
PLUG FOR BATHTUB  
COD. 3.PVR € 99,00

# Avio

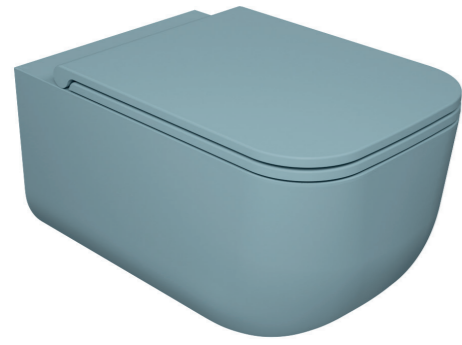

VASO SOSPESO AVIO  
AVIO WALL HUNG WC  
COD. 4.WCSR € 899,00

SEDILE SLIM SOFT CLOSE CAMELIA  
SLIM CAMELIA SOFT CLOSE SEAT COVER  
COD. 4.CWR € 177,00



BIDET SOSPESO AVIO  
AVIO WALL HUNG BIDET  
COD. 4.BDSR € 840,00

PILETTA PER BIDET  
PLUG FOR BIDET  
COD. 4.CWR € 59,00



LAVABO QUBE 9 AVIO  
AVIO WASHBASIN QUBE 9  
COD. 4.LVQ 9 € 499,00

PILETTA PER LAVABO  
PLUG FOR WASHBASIN  
COD. 4.PLR € 59,00



CONSOLLE IN CERAMICA COTONE  
COTONE CERAMIC WASHBASIN  
COD. 1.LVR € 599,00

PILETTA CERAMICA PER LAVABO COTONE  
CERAMIC PLUG FOR WASHBASIN COTONE  
COD. 1.PIL € 63,00

STRUTTURA PORTANTE 300X490XH300 CON 2 CASSETTI AVIO,  
COMPLETO DI STAFFE DI FISSAGGIO.  
FREE STANDING CABINET 300X490XH300 WITH 2 DRAWERS,  
FIXING KIT INCLUDED.  
COD. 3.CAR € 399,00

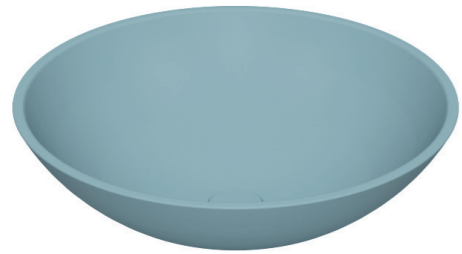

LAVABO FLAT 7 AVIO  
AVIO WASHBASIN FLAT 7  
COD. 3.LVF 7 € 399,00

PILETTA PER LAVABO  
PLUG FOR WASHBASIN  
COD. 4.PLR € 59,00

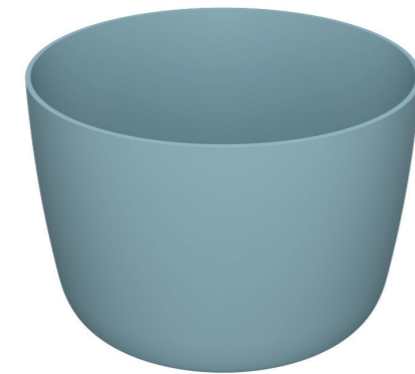

LAVABO FLAT 9 AVIO  
AVIO WASHBASIN FLAT 9  
COD. 3.LVF 9 € 669,00

PILETTA PER LAVABO  
PLUG FOR WASHBASIN  
COD. 4.PLR € 59,00



LAVABO FLAT 8 AVIO  
AVIO WASHBASIN FLAT 8  
COD. 4.LVF 8 € 499,00

PILETTA PER LAVABO  
PLUG FOR WASHBASIN  
COD. 4.PLR € 59,00

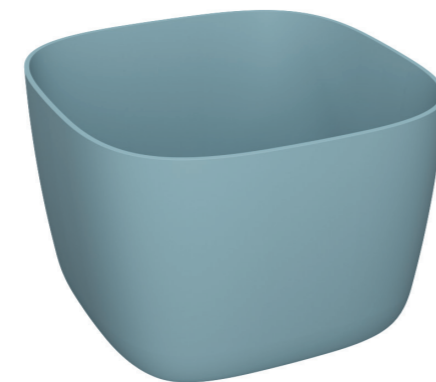

LAVABO QUBE 10 AVIO  
AVIO WASHBASIN QUBE 10  
COD. 3.LVQ 10 € 659,00

PILETTA PER LAVABO  
PLUG FOR WASHBASIN  
COD. 4.PLR € 59,00



LAVABO QUBE 8 AVIO  
AVIO WASHBASIN QUBE 8  
COD. 4.LVQ 8 € 2.299,00

PILETTA PER LAVABO  
PLUG FOR WASHBASIN  
COD. 4.PLR € 59,00



VASCA AVIO  
AVIO WASHBASIN QUBE 8  
COD. 4.VR € 5.500,00

PILETTA PER VASCA  
PLUG FOR BATHTUB  
COD. 4.PVR € 99,00

# AREA TECNICA

Sul sito [sdrkeramiche.it](http://sdrkeramiche.it) potete scaricare: Schede tecniche sempre aggiornate in formato A4 e istruzioni di montaggio.  
Please download on [sdrkeramiche.it](http://sdrkeramiche.it): latest technical sheets in A4 format and fixing instruction.

## Revolution

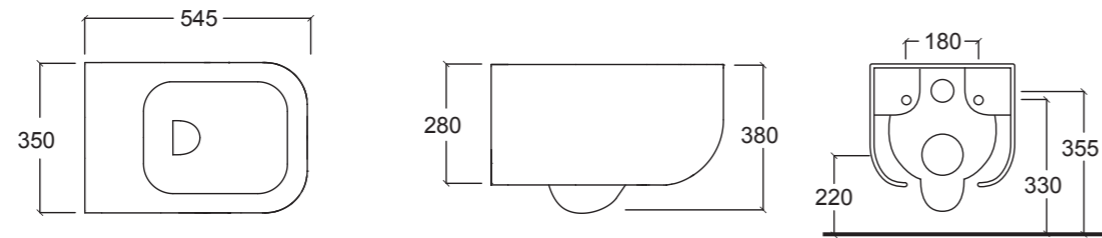

Art. WCF  
Vaso rimless con scarico a parete trasformabile a pavimento tramite curva tecnica  
Free standing rimless wc with wall trap chargeable into floor trap by technical bend

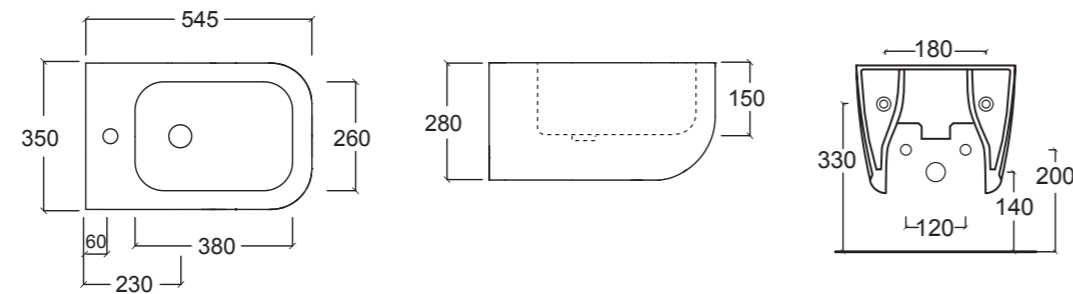

Art. BDF  
Bidet monoforo sospeso senza troppopieno  
Wall hung single hole bidet without overflow



## Revolution

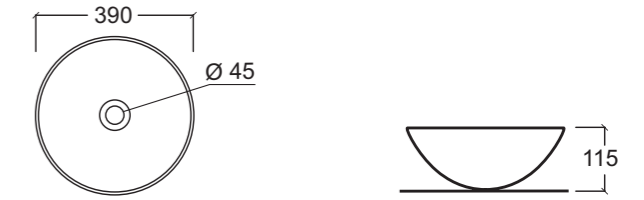

\_LAVABO FLAT 7

Art. LVF7  
Lavabo da appoggio diametro 39 cm senza troppopieno  
Laid on washbasin diameter 39 cm without overflow

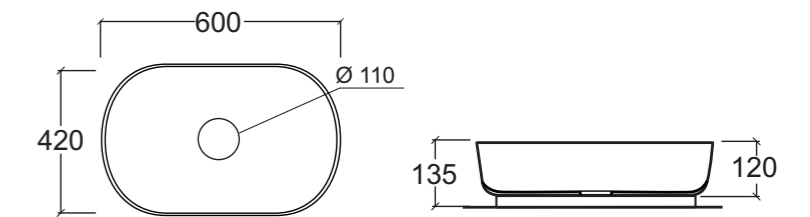

\_LAVABO FLAT 8

Art. LVF8  
Lavabo da appoggio 60x42 cm senza troppopieno  
Laid on washbasin 60x42 cm without overflow

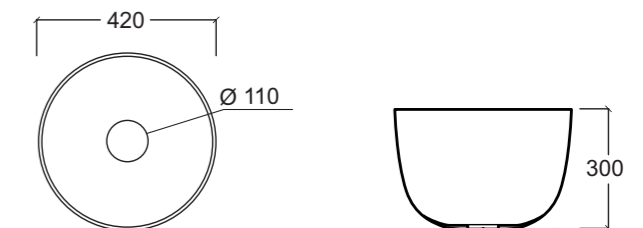

\_LAVABO FLAT 9

Art. LVF9  
Lavabo da appoggio diametro 42x30 cm senza troppopieno  
Laid on washbasin diameter 42x30 cm without overflow

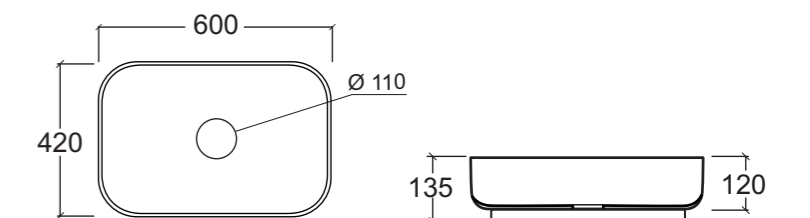

\_LAVABO QUBE 9

Art. LVQ9  
Lavabo rettangolare da appoggio 60x42 cm senza troppopieno  
Laid on rectangular washbasin 60x42 cm without overflow



# Revolution



\_LAVABO QUBE 10

Art. LVQ10  
Lavabo quadrato da appoggio 42x42xh30 cm senza troppopieno  
Laid on square washbasin 42x42xh30 cm without overflow

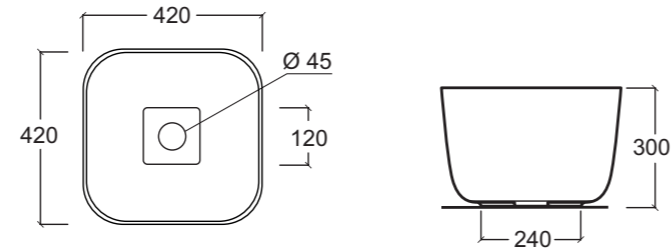

\_CONSOLLE

Art. LVR  
Consolle 95x48xh13 cm in ceramica cotone  
Ceramic cotone console 95x48xh13 cm

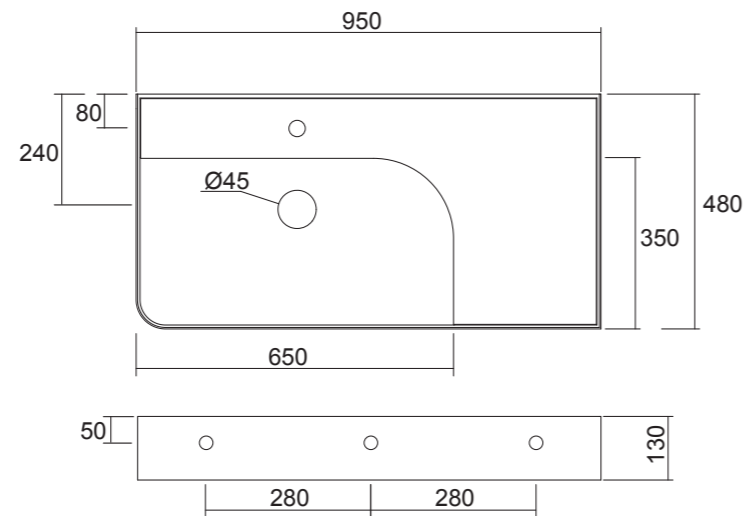

Art. 1.CAR (finitura COTONE)  
Struttura portante 300x490xh300 con 2 cassetti,  
completo di staffe di fissaggio.  
Free standing cabinet 300x490xh300 with 2 drawers,  
fixing kit included.

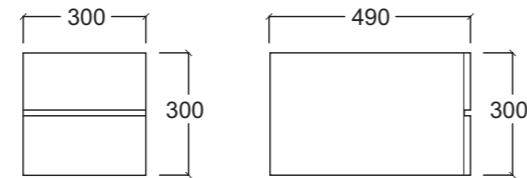

## ESEMPI DI INSTALLAZIONE EXAMPLE OF INSTALLATION

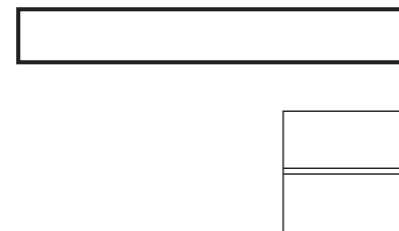
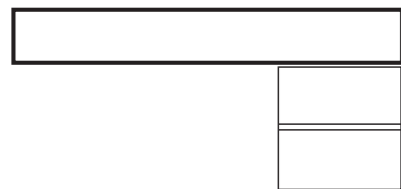

# Revolution



\_LAVABO FREESTANDING QUBE 8

Art. LVQ8  
Lavabo monoblocco in solid surface senza troppopieno  
Solid surface free standing washbasin without overflow

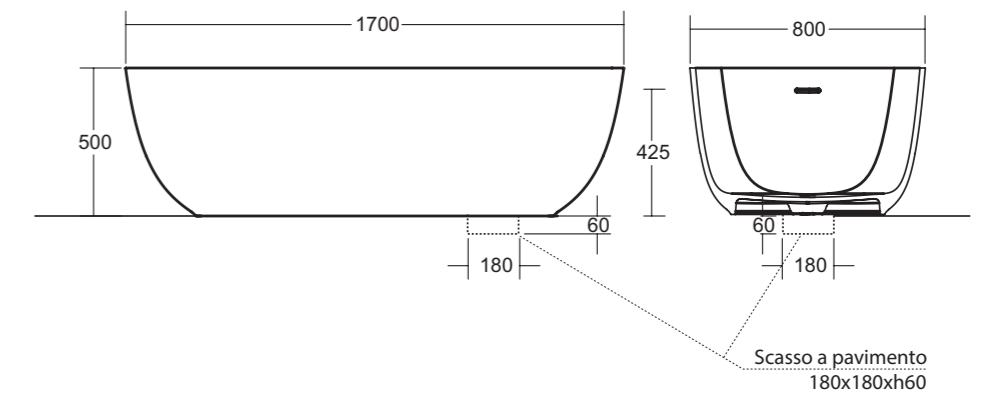
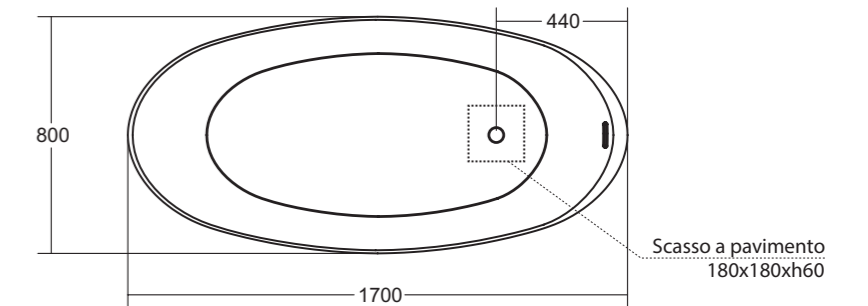
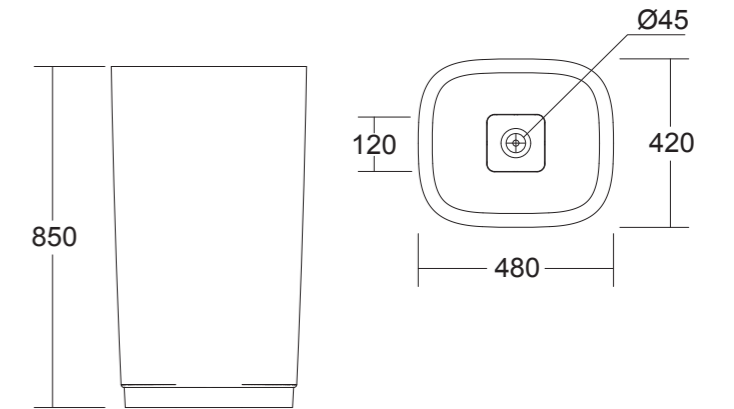

\_VASCA REVOLUTION

Art. VR  
Vasca in solid surface installabile in centro stanza  
Free standing solid surface bath tub



Il colore di stampa è indicativo e potrebbe differire dall'originale. Tolleranza sulle misure +/- 5mm  
The printing color is indicative and may differ from the original. Tolerance on measurements +/- 5mm

# CONDIZIONI DI VENDITA

## IL PRESENTE LISTINI ANNULLA E SOSTITUISCE OGNI PRECEDENTE

1) ORDINI: gli ordini dovranno essere passati alla società e dalla stessa confermate, sia per condizioni commerciali, che per date di consegna. E' sempre richiesta una conferma d'ordine controfirmata per accettazione, in assenza della stessa la ditta non si assume alcuna responsabilità per eventuali errori presenti nella stessa.

2) TRASPORTO: la merce è venduta franco fabbrica e viaggia a rischio e pericolo del committente, il trasporto è sempre a carico del committente, per conto del quale la società esegue la spedizione.

3) IMBALLO: effettuato su pallet chiuso con termoretrailabile, verrà addebitato un rimborso spese pari al 3% dell'importo della fornitura.

4) PAGAMENTI: i pagamenti debbono essere effettuati esclusivamente presso la sede della società, salvo diversamente pattuito , il mancato pagamento di una eventuale fornitura, autorizza la S.D.R. Ceramiche S.r.l. a sospendere le forniture in corso. In caso di contestazione di qualsiasi natura il committente non ha diritto di sospendere i pagamenti. EMISSIONE RI.BA. € 3,50

5) CONSEGNE: i termini di consegna sono puramente indicativi, pertanto la società non si assume responsabilità di nessun genere , salvo non espressamente pattuito.

6) RECLAMI: dovranno pervenire entro e non oltre 8 giorni dal ricevimento della merce.

7) RISERVA DI PROPRIETA' : fino a che il pagamento non sia stato completato, la merce rimane di proprietà della società venditrice.

8) INTERESSI MORATORI E RITARDATO PAGAMENTO: Il ritardato pagamento rispetto alla data pattuita darà luogo all'addebito delle spese per insoluti, degli interessi di mora di cui all'art. 5 del D.Lgs. 231/02, dei costi di recupero ex art. 6 Dlgs 231/2002 e produrrà la perdita per l'acquirente del beneficio del termine ai sensi dell'art. 1186 c.c., rendendo immediatamente esigibili eventuali somme non ancora scadute.

9) MODALITA' RIVENDITA DEI PRODOTTI : I marchi i modelli e i disegni ornamentali relativi ai prodotti oggetto del presente listino sono di proprietà esclusiva della S.D.R. CERAMICHE Srl o comunque in diritto di concessione, pertanto ogni abuso ed utilizzo improprio, con ogni mezzo, darà diritto alla S.D.R. CERAMICHE Srl oltre che ad azioni inibitorie, anche alla sospensione di tutte le forniture, il ritiro della merce consegnata a spese dell'acquirente ed al risarcimento danni con ogni ulteriore sanzione prevista dalla legge. E' fatto altresì divieto di rivendere online, in qualsiasi forma, i prodotti oggetto del presente listino, se non su espressa e scritta autorizzazione della S.D.R. CERAMICHE Srl. In caso contrario la S.D.R. CERAMICHE Srl oltre ad intraprendere qualsiasi tipo di azione, avrà la facoltà di sospendere tutte le forniture, ritirare la merce consegnata a spese dell'acquirente. La S.D.R. CERAMICHE Srl avrà inoltre diritto al risarcimento danni ed applicherà una penale pari ad Euro 100,00 per ogni giorno in cui il prodotto è stato pubblicato al fine della vendita online.

10) DATI DEL COMMITTENTE: il committente è responsabile di tutti i dati identificativi in particolare per quanto si riferisce alle norme relative all'anagrafe tributaria (Codice Fiscale).

11) FORO COMPETENTE: per qualsiasi controversia si considera competente il Foro dove ha sede la ditta venditrice.

12) MODIFICHE: la S.D.R. Ceramiche S.r.l. si riserva il diritto di apportare senza obbligo di preavviso alcuno tutte le modifiche e/o migliorie tecniche , costruttive e dimensionali utili al miglioramento della produzione.

13) DATI TECNICI: i colori illustrati sul catalogo hanno valore di riferimento e non ci impegnano nella loro fedele esecuzione. Le misure sono da considerarsi indicative e sono suscettibili a variazione a causa delle caratteristiche peculiari della produzione ceramica.

# CONDITIONS OF SALE

## THIS PRICE LIST CANCELS ANY ANY PREVIOUS ISSUE

1) ORDERS: must be placed to the Firm, which will confirm conditions and delivery terms. Signed copy of the order is always request as confirmation to avoid any mistake between the parties.

2) TRANSPORT: goods are sold on ex-factory basis and transport is carried out at the customer's own risk.

3) PACKAGING: is on pallet closed with thermoshrink plastic cap , 3% of consignment value will be debited on the invoice.

4) PAYMENT: payment must be done exclusively to the Firm. Failure to pay a previous supply allows the Company to stop shipping the goods of any pending order.

5) DELIVERY: dates are merely approximate, consequently the supplying Firm bares no responsibility for delivery terms, unless otherwise agreed upon.

6) CLAIM: must be submitted to our main office within 8 days upon receipt of the goods.

7) RIGHT OF OWNERSHIP: until payment is fully settled , the goods are still property of the Firm.

8) INTEREST ON DELAYED PAYMENT: should be there any delay in payment , interest will be charged at the rate fixed by credit by credit institutions at the date of debiting.

9) MODALITA' RIVENDITA DEI PRODOTTI : The trademarks, and designs relating to the products in this price list are the exclusive property of S.D.R. CERAMICHE Srl , therefore any abuse and improper use, by any means, will be entitled to the S.D.R. CERAMICHE Srl as well as for injunctions, also the suspension of all supplies, the collection of the goods delivered at the expense of the purchaser and compensation for damages with any further sanction required by law. It is also forbidden to sell online, in any form, the products in this price list, unless expressly and in writing authorized by S.D.R. CERAMICHE Srl. Otherwise the S.D.R. CERAMICHE Srl in addition to taking any type of action, will have the right to suspend all supplies, collect the goods delivered at the expense of the buyer. The S.D.R. CERAMICHE Srl will also be entitled to compensation for damages and will apply a penalty equal to Euro 100.00 for each day on which the product was published for online sale

10) COSTUMER DETAILS: the customer is responsible for all identifications detail provided, in particular to those referring the tax register (Tax Code).

11) LEGEL RESIDENCE: for any controversy the competent court is the court of Viterbo (ITALY)

12) MODIFICATIONS: S.D.R. Ceramiche S.r.l. reserves the right to make at any moment any technical, constructive or dimensional change useful the improve the production and / or the product. Color and dimension are to be considered approximate and susceptible to variations because of the specific characteristics of the Ceramic production cycle.

## Credits

### Art Direction

Luca Papini

### Testi

Luca Papini Design Studio

### Immagini

Chromatika Multimedia

### Printed by

Telligraf srl



**esedra**

S.D.R. Ceramiche s.r.l.

Località Quartaccio, snc - 01034 Fabrica di Roma (VT)

Tel. +39 0761 541055 - Fax +39 0761 598449

info@sdrceramiche.it - www.sdrceramiche.it

2018- all rights reserved©

Il marchio ed il logo **esedra**® **REVOLUTION**® **LIVIN-STONE**® sono marchi registrati. SDR Ceramiche SRL diffida l'utilizzo dei propri marchi, loghi, nomi di dominio e ragione sociale anche nei Paesi in cui non sono registrati; È vietato pertanto qualsiasi utilizzo senza il consenso della SDR Ceramiche SRL. Tutti i diritti qui non espressamente richiamati sono riservati. Tutte le immagini contenute nel presente catalogo sono di proprietà di SDR Ceramiche

**esedra**® **REVOLUTION**® **LIVIN-STONE**® brand and logo are trademarks. SDR Ceramiche SRL distrusts the use of its trademarks, logos, domain names and company names even in countries where they are not registered; it is strictly forbidden any use without the consent of SDR Ceramiche SRL. All rights are reserved. All the images are property of SDR Ceramiche SRL.