



FritsJurgens®

FritsJurgens Pivot Door System

# System3

MOUNTING MANUAL  
2015-06

# INDEX

SITUATION	3
MILLING DRAWING	4
COMPONENTS	6
MANUAL	8

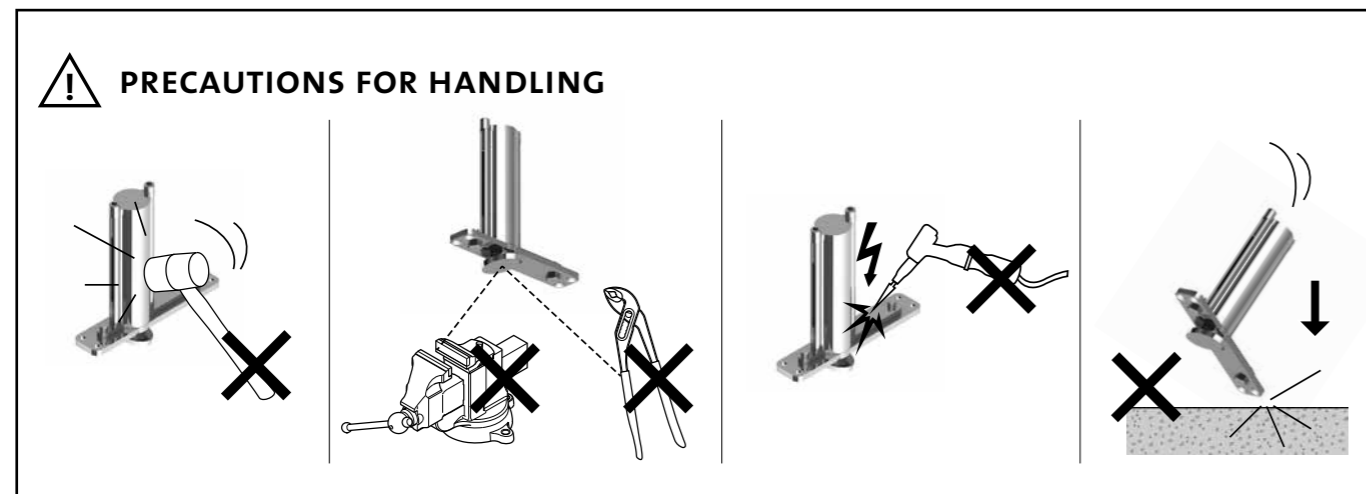

# SITUATION

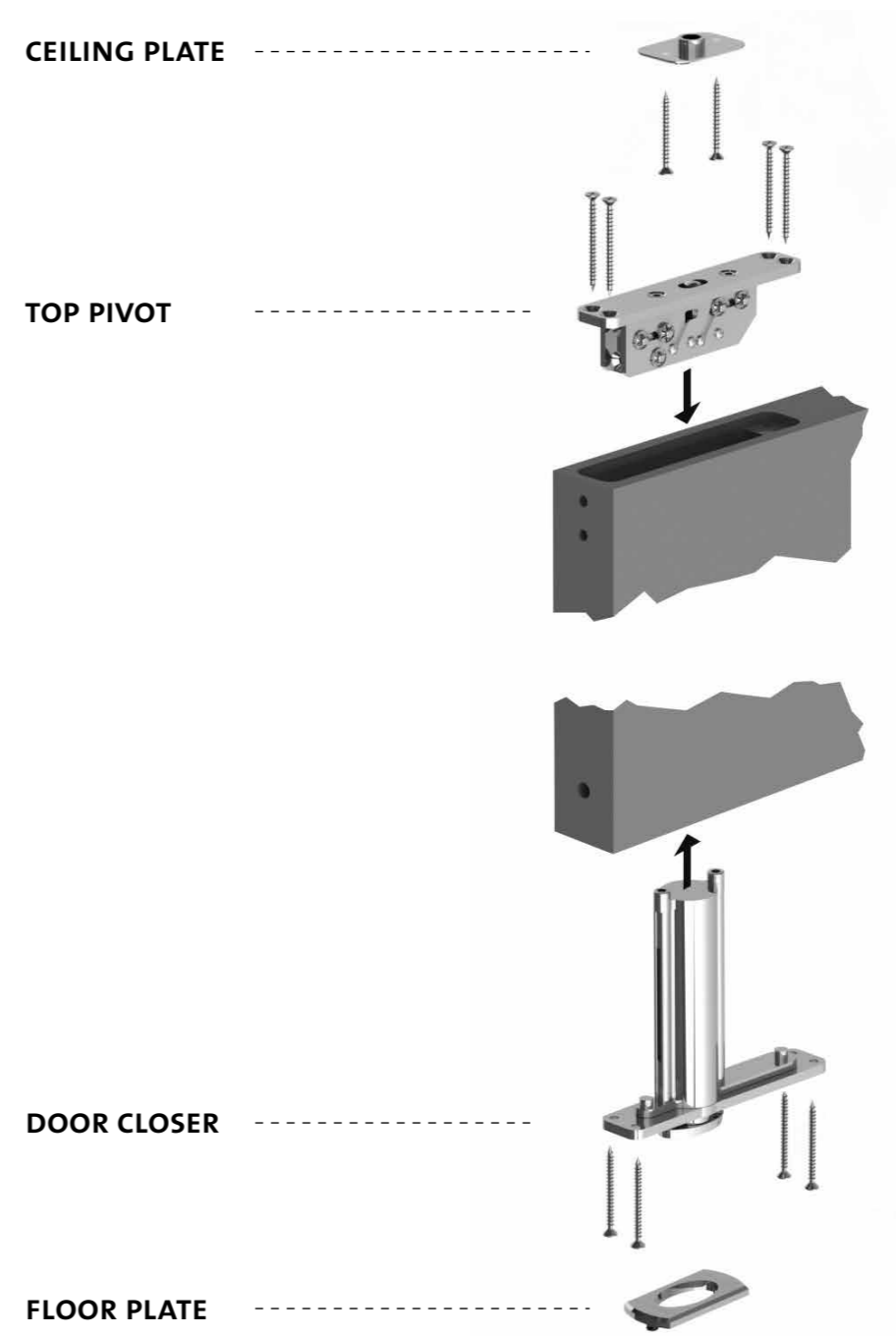

# MILLING DRAWING

## DOOR CLOSER

FRITSJURGENS MPDS-S80 RVS 90##

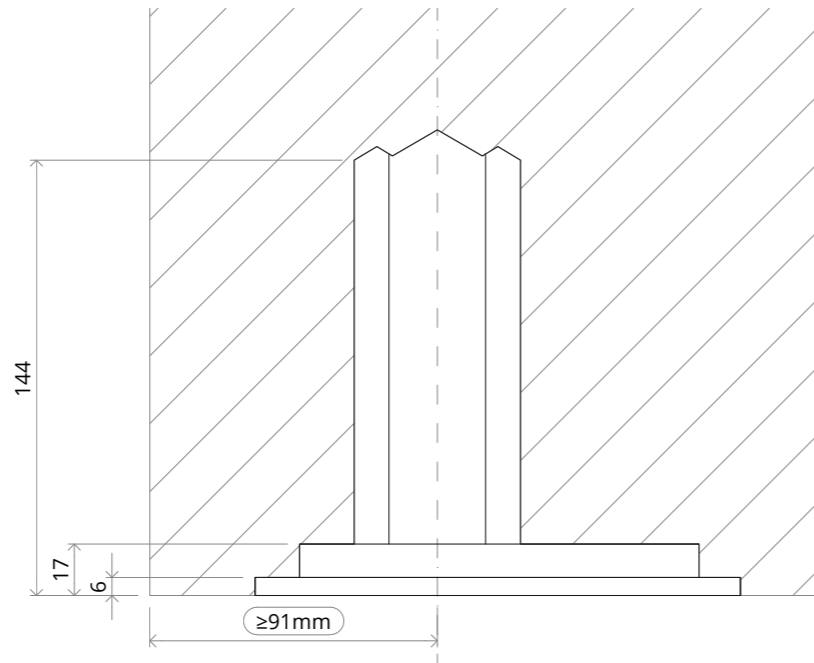
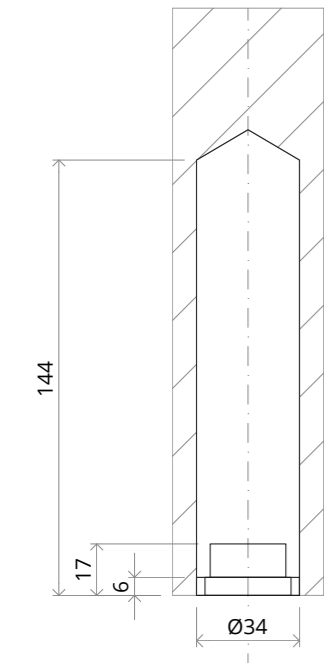
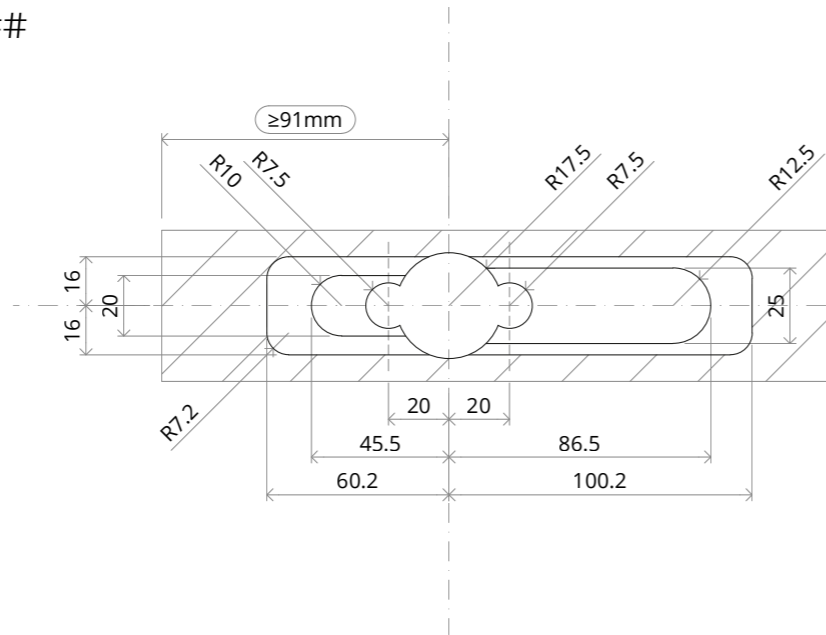

# MILLING DRAWING

## TOP PIVOT

FRITSJURGENS MPDS-ATC-9001

FRITSJURGENS MPDS-ATC-9101

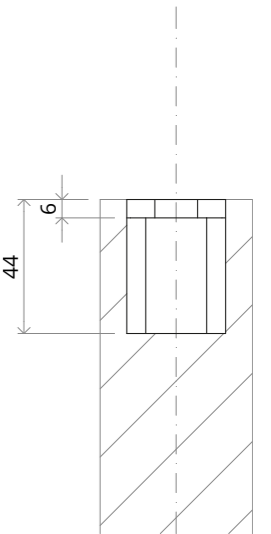
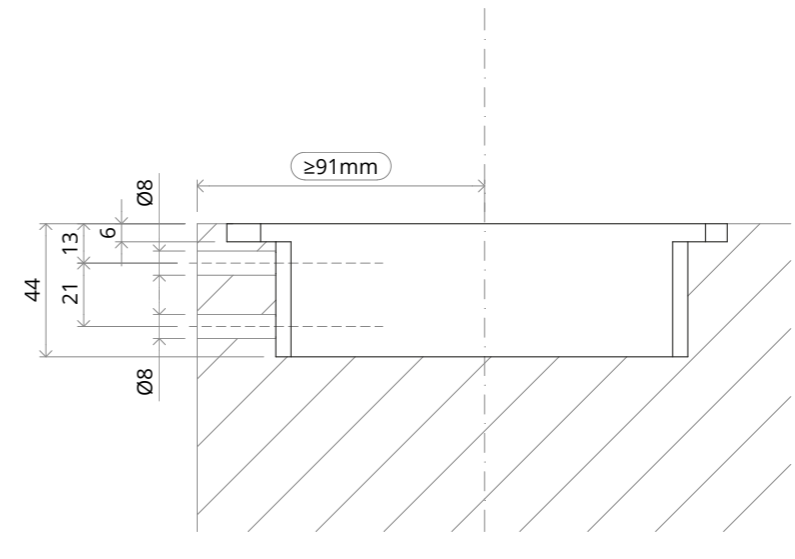
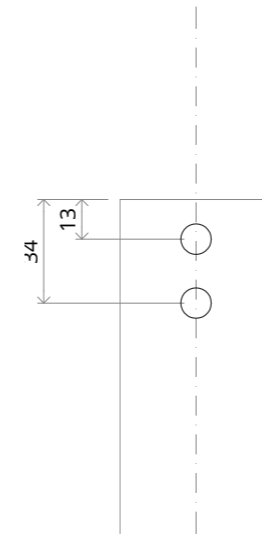
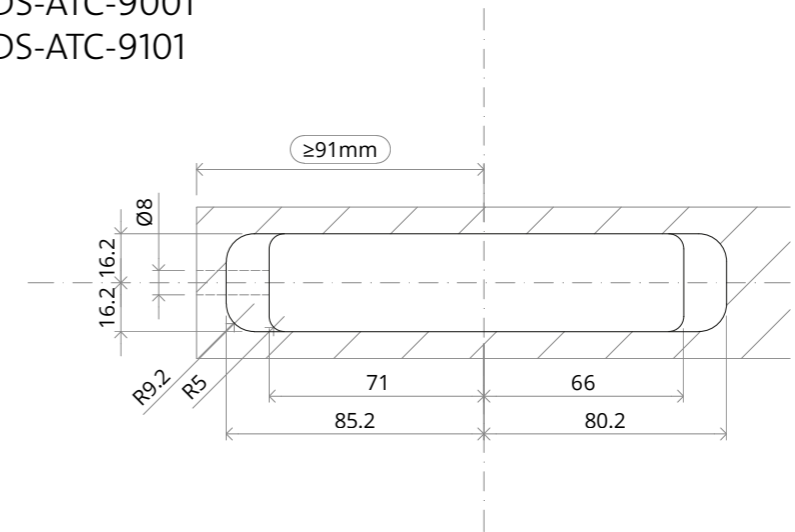

## COMPONENTS



### DOOR CLOSER

FRITSJURGENS MPDS-S80 RVS 9016  
FRITSJURGENS MPDS-S80 RVS 9020  
FRITSJURGENS MPDS-S80 RVS 9024  
FRITSJURGENS MPDS-S80 RVS 9028

	9016	= ≥ 650mm		9016	= ≤ 40kg
	9020	= 650 - 800mm		9020	= ≤ 70kg
	9024	= 800 - 1000mm		9024	= ≤ 110kg
	9028	= 1000 - 1500mm		9028	= ≤ 200kg



### TOP PIVOT

FRITSJURGENS MPDS-ATC-9001  
FRITSJURGENS MPDS-ATC-9101 \*

\* Part deviates from picture



### FLOOR PLATE

FRITSJURGENS VP 80x40-B11 RVS  
FRITSJURGENS VPR 80-B01 RVS \*  
FRITSJURGENS VP 82x52-B01 RVS \*

\* Part deviates from picture



### CEILING PLATE

FRITSJURGENS PP 40x60-B11 RVS  
FRITSJURGENS PPR 80-B01 RVS \*  
FRITSJURGENS PP 40x60-B9101 \*

\* Part deviates from picture

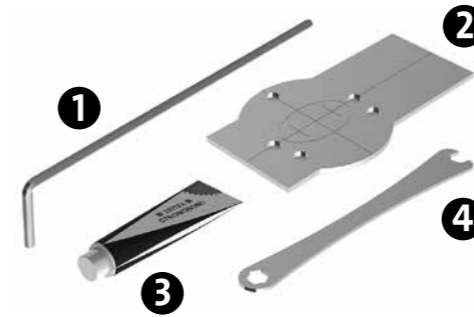

### MOUNTING PACKAGE

FRITSJURGENS MP F-M SERIES

1. Allen wrench
2. Fitting template
3. Fitting adhesive \*
4. Adjustment spanner

\* For bro's floors use chemical mortar



### SCREWS

FRITSJURGENS FASTENING

- A. Screw 6 x 60 RVS (2x)  
B. Screw 4 x 50 RVS (8x)

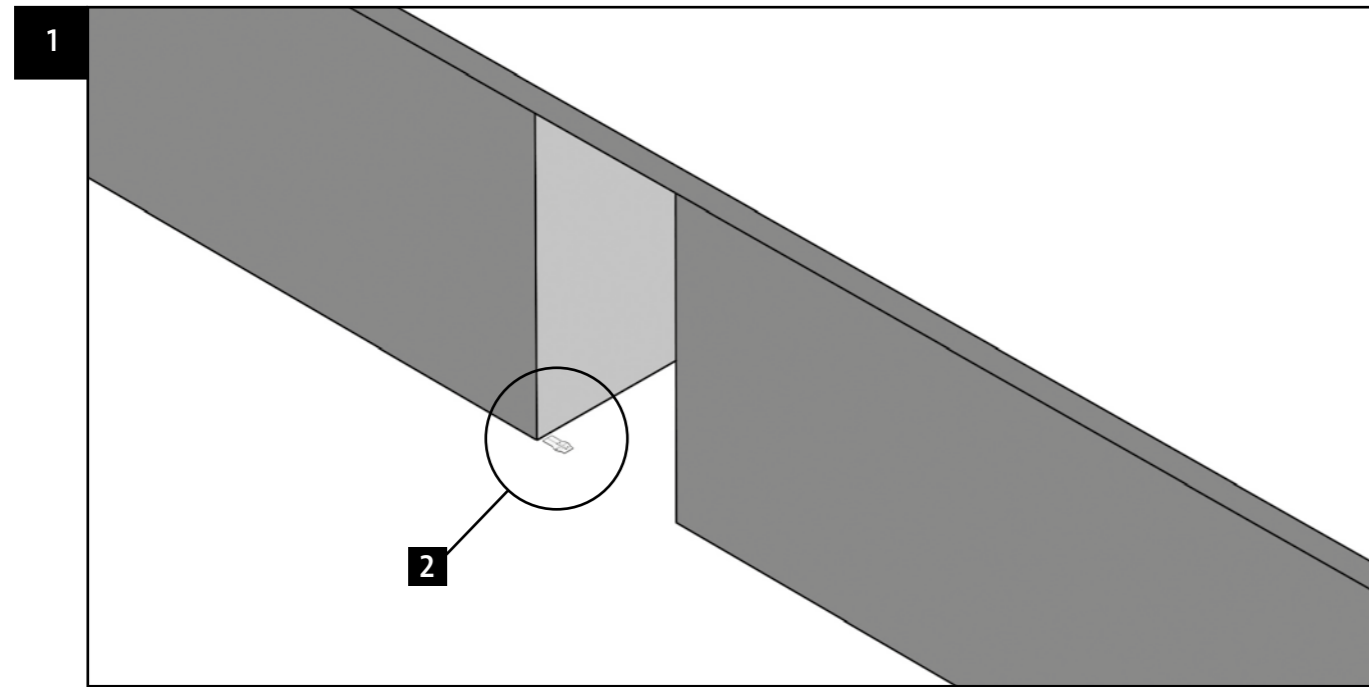

IMAGE FJ01

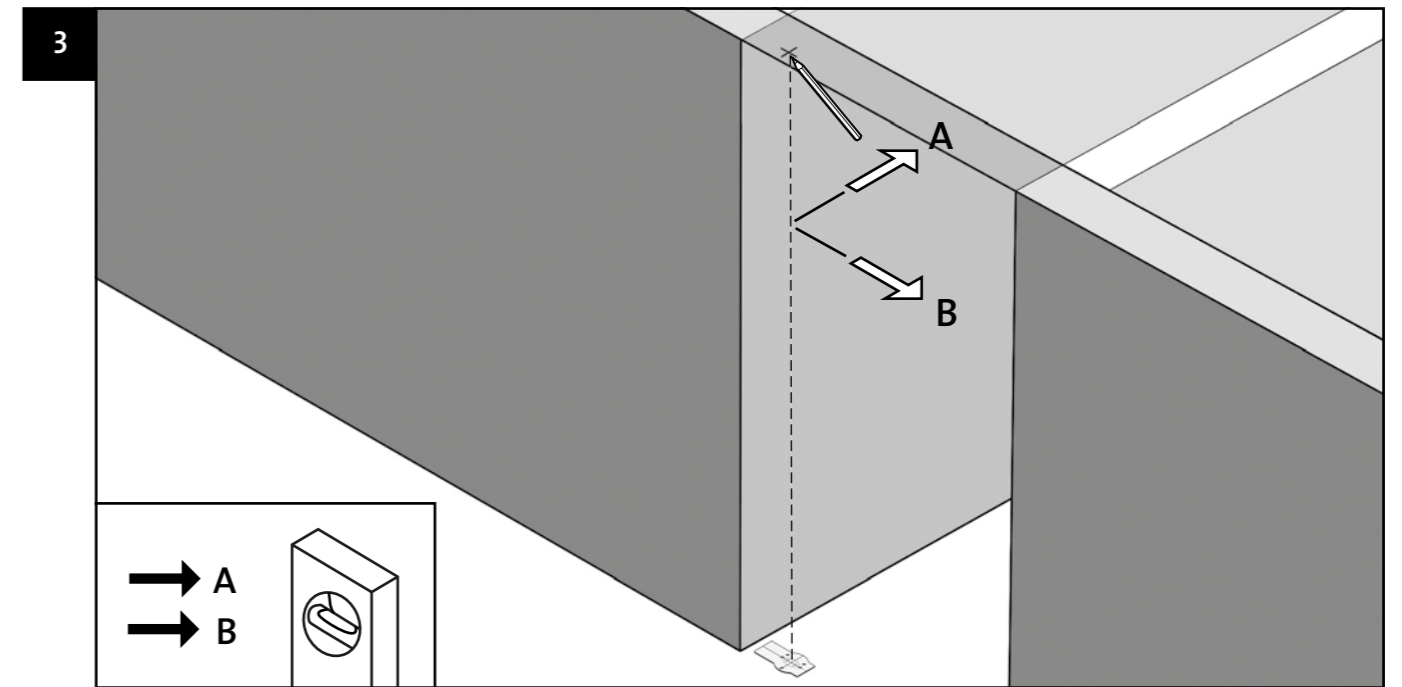

IMAGE FJ03

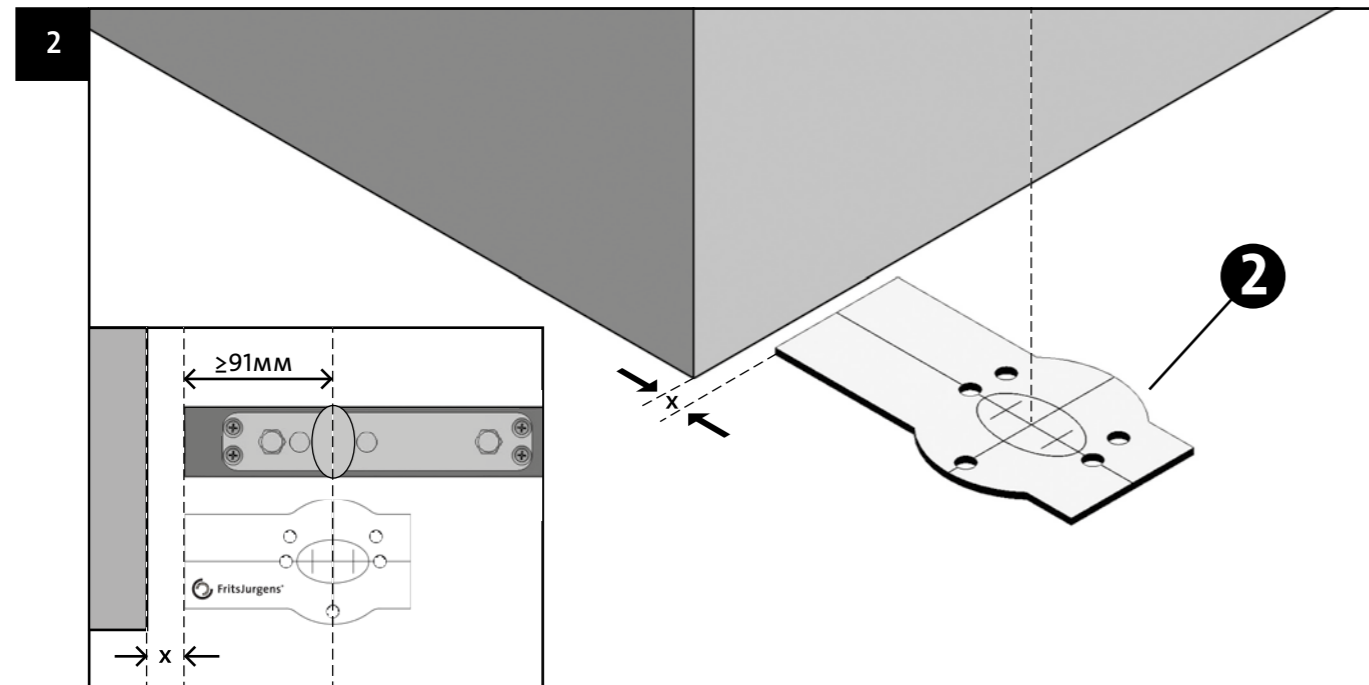

IMAGE FJ02

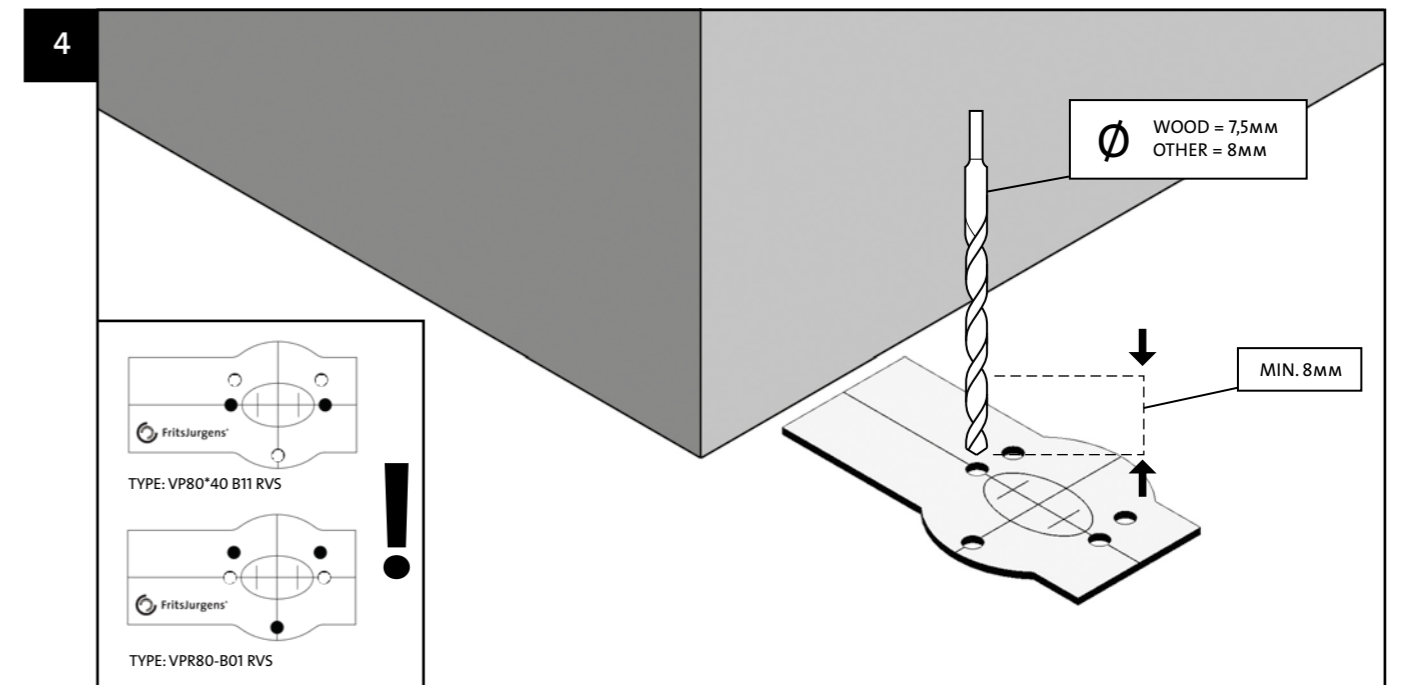

IMAGE FJ04

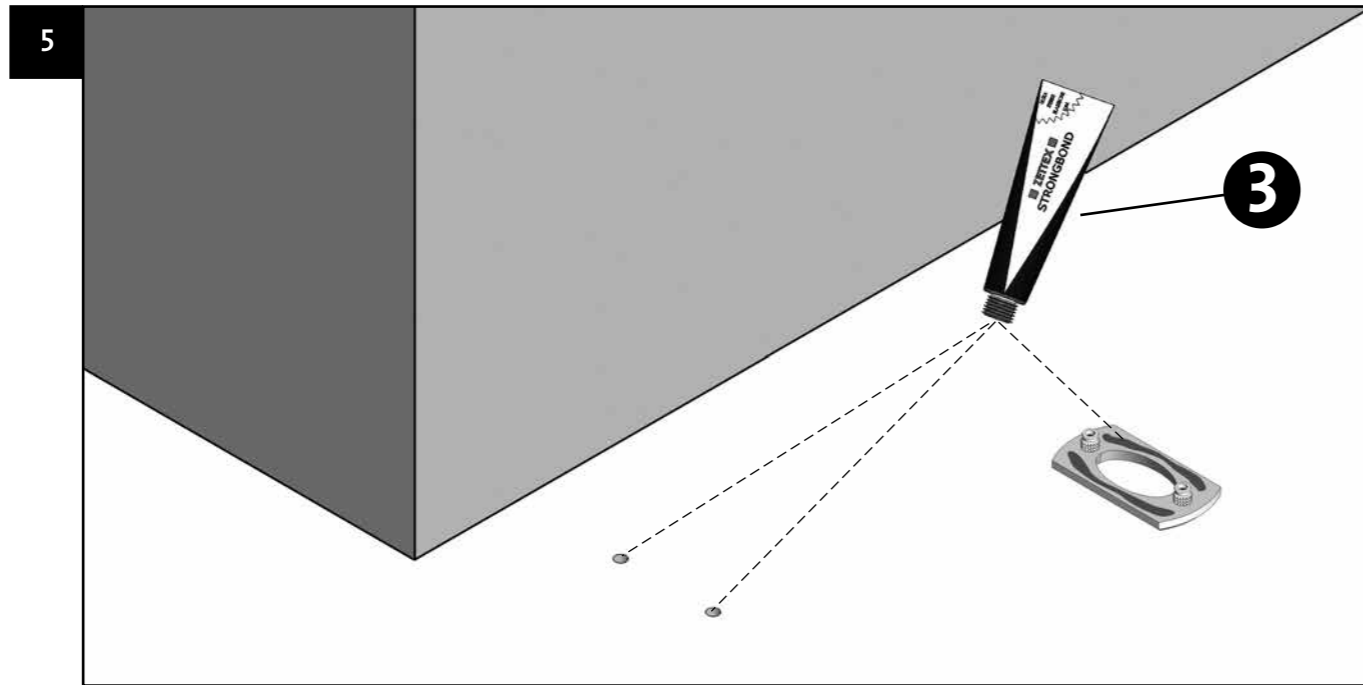

IMAGE FJ05

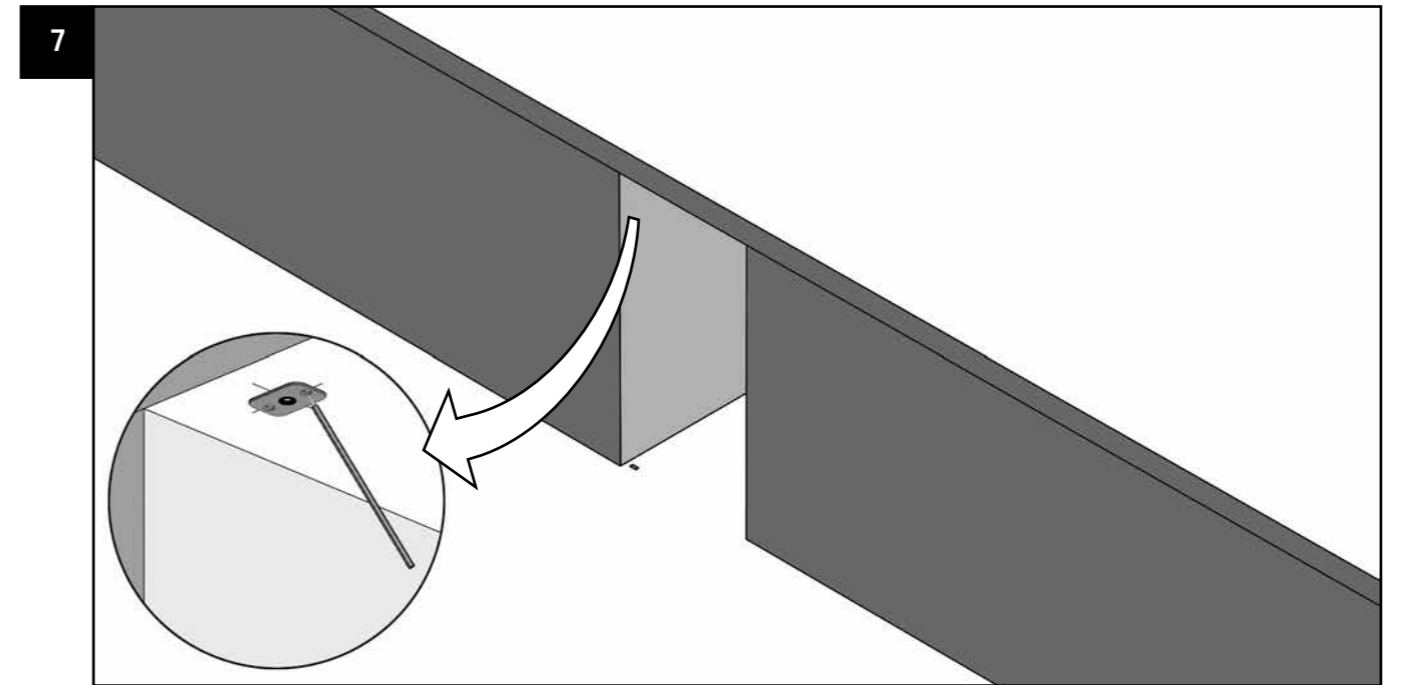

IMAGE FJ07

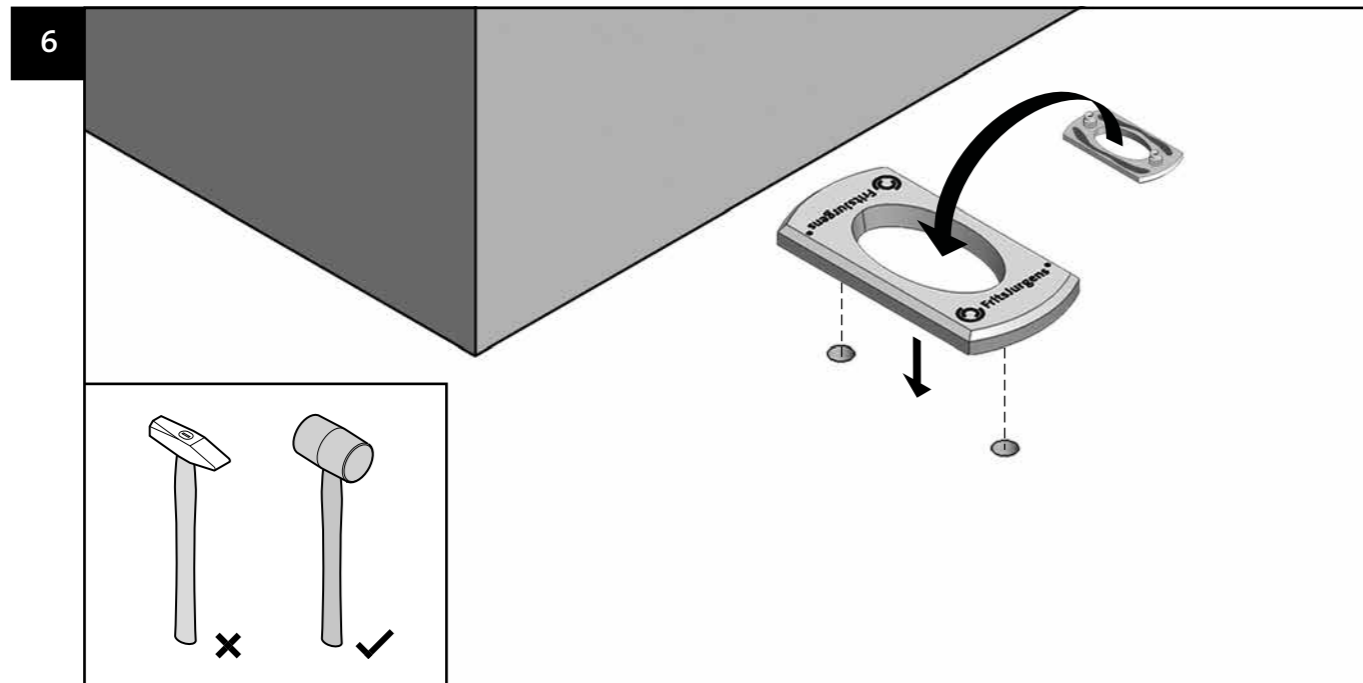
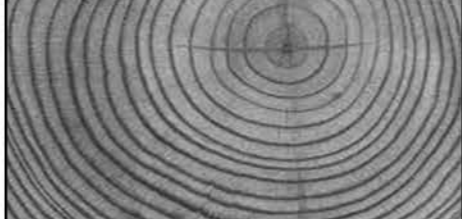

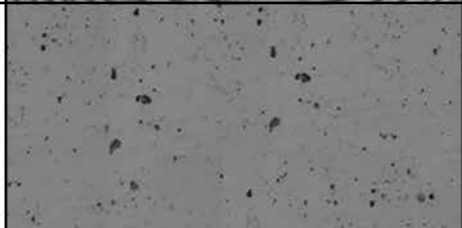





IMAGE FJ06

8	WOOD		 A
	STONE		*  +  A
	STEEL		*  M5

\* EXCL.

IMAGE FJ08

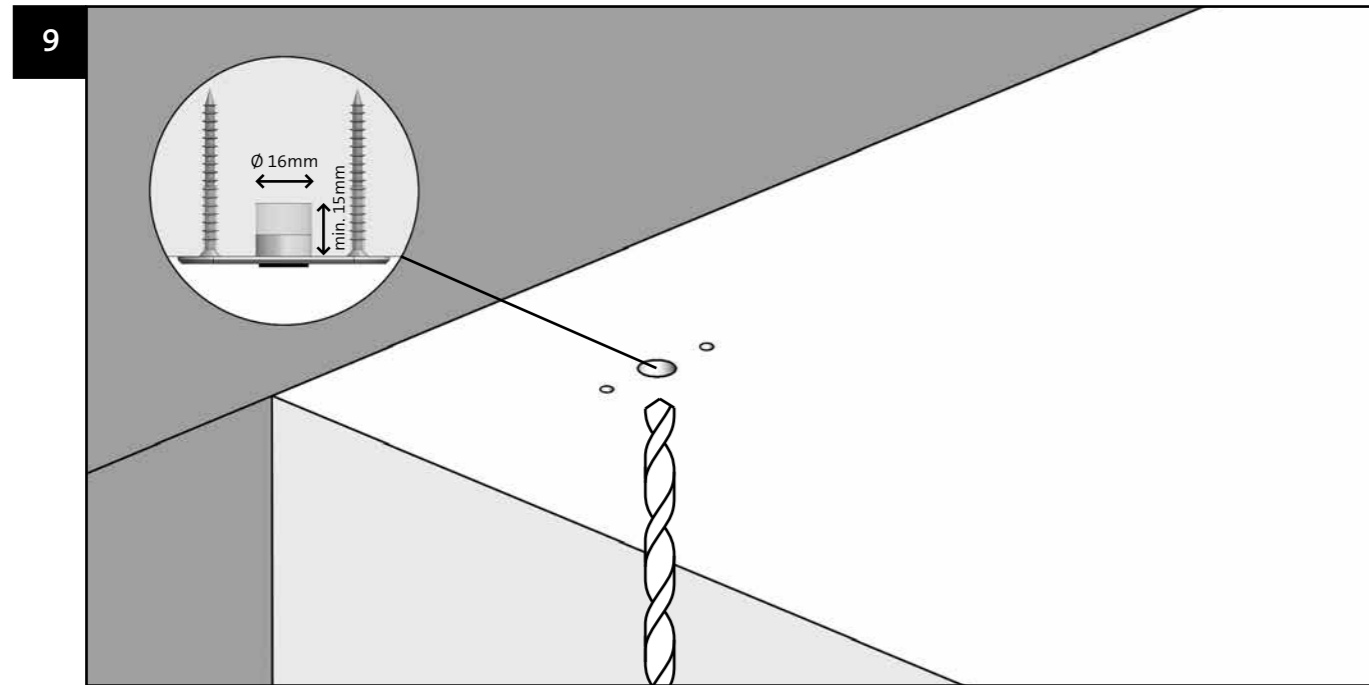

IMAGE FJ09

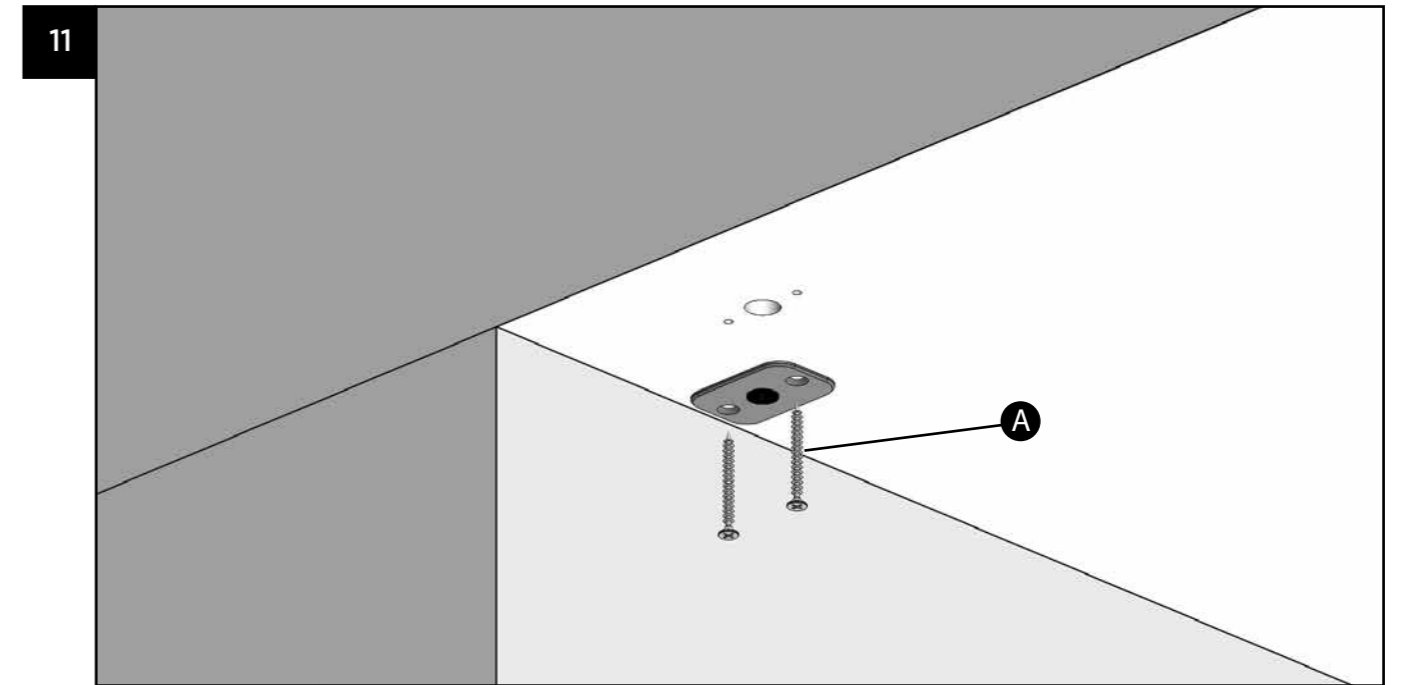

IMAGE FJ11

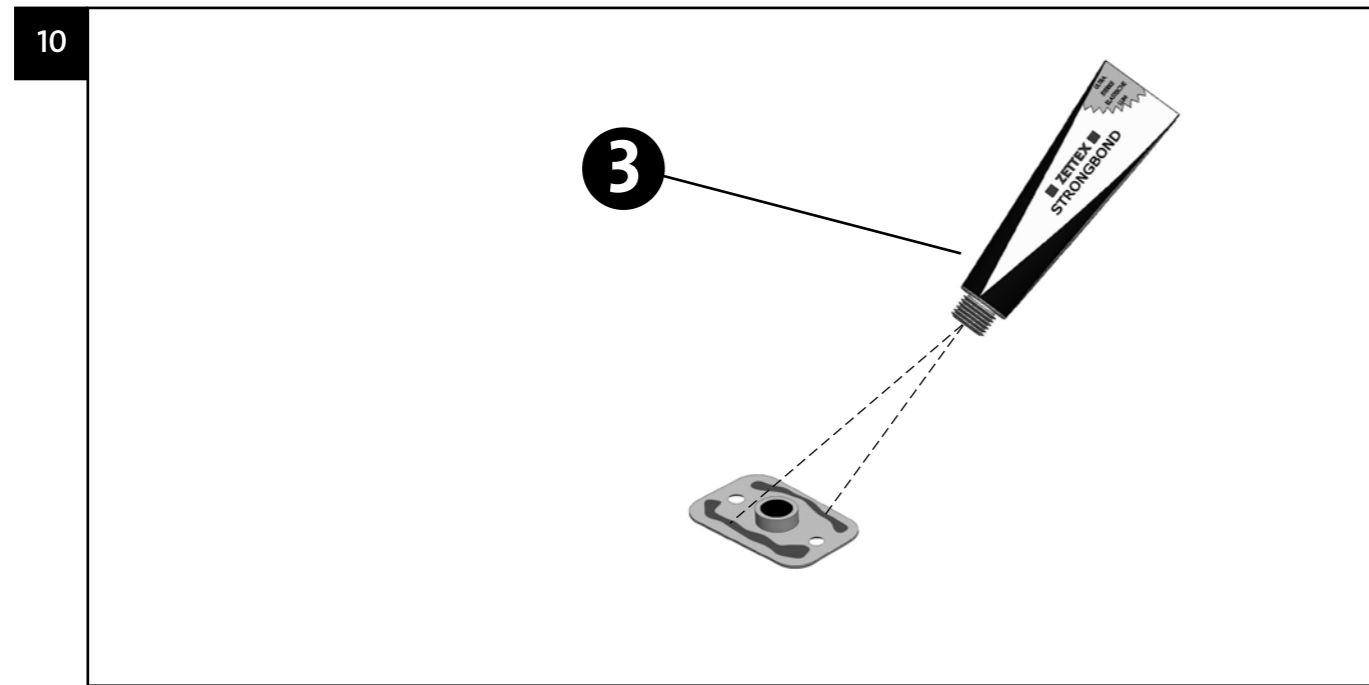

IMAGE FJ10

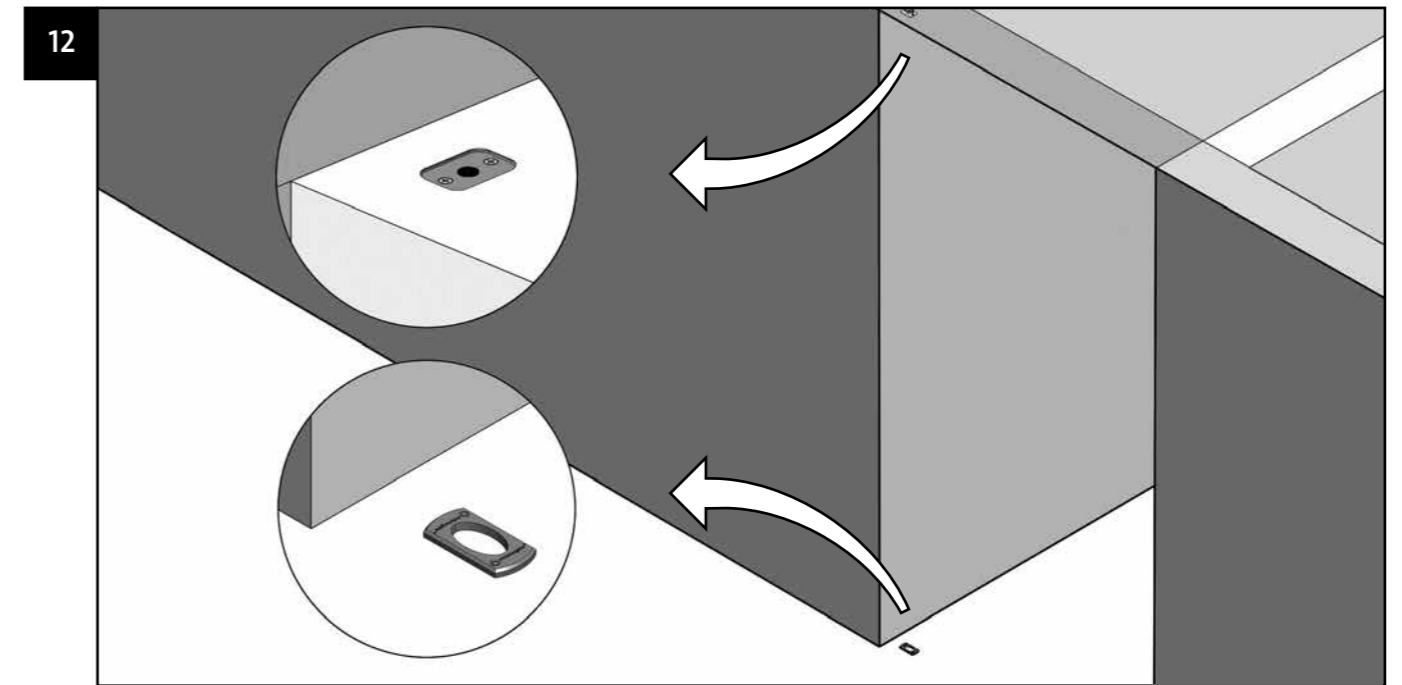

IMAGE FJ12

13

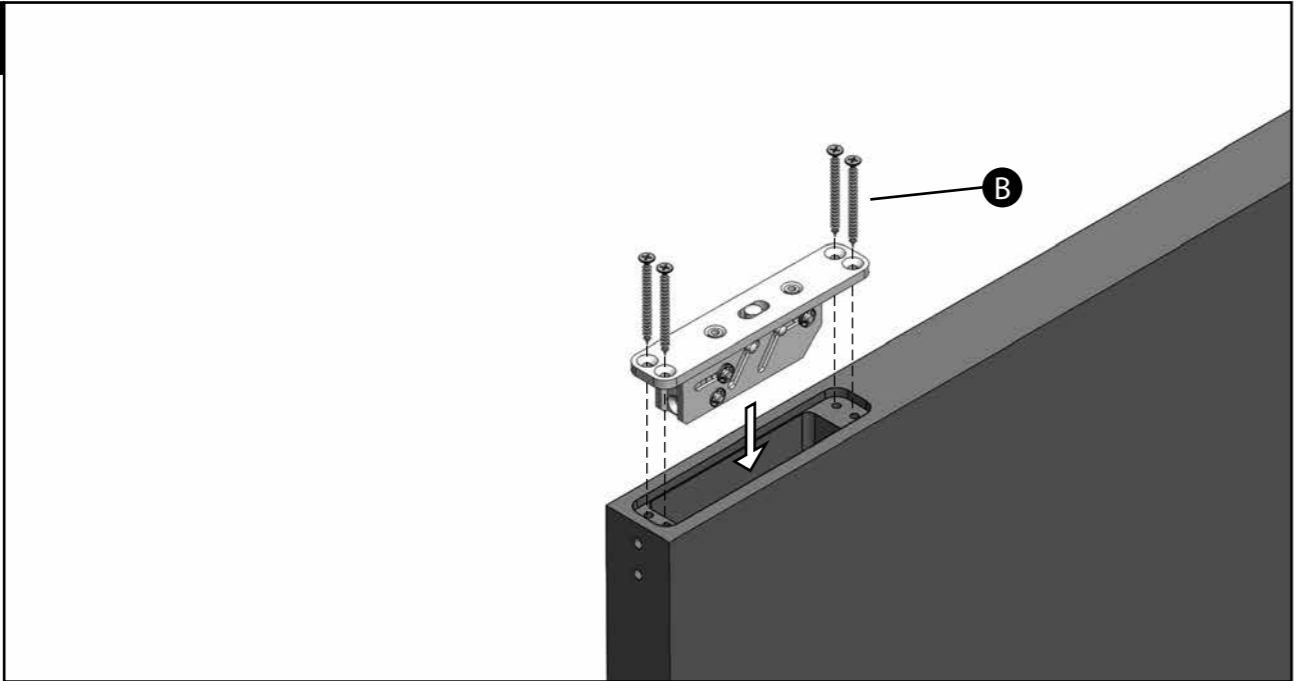

IMAGE FJ13

15

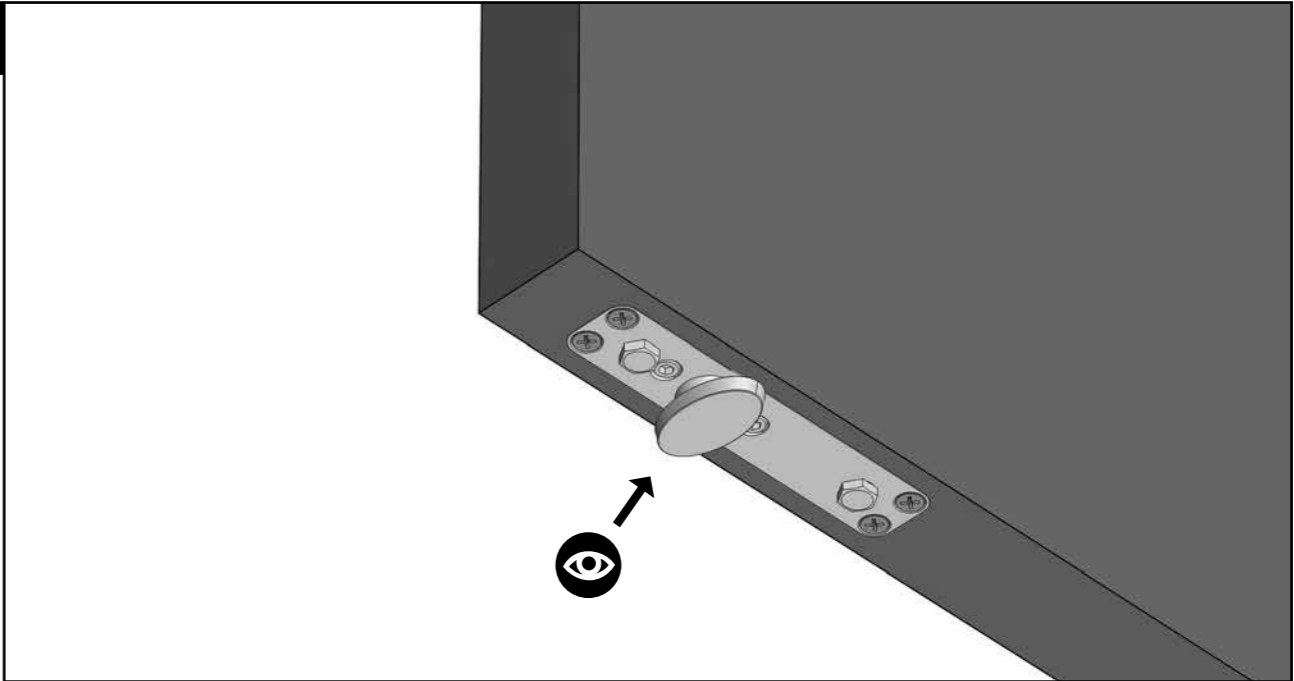

IMAGE FJ15S3

14

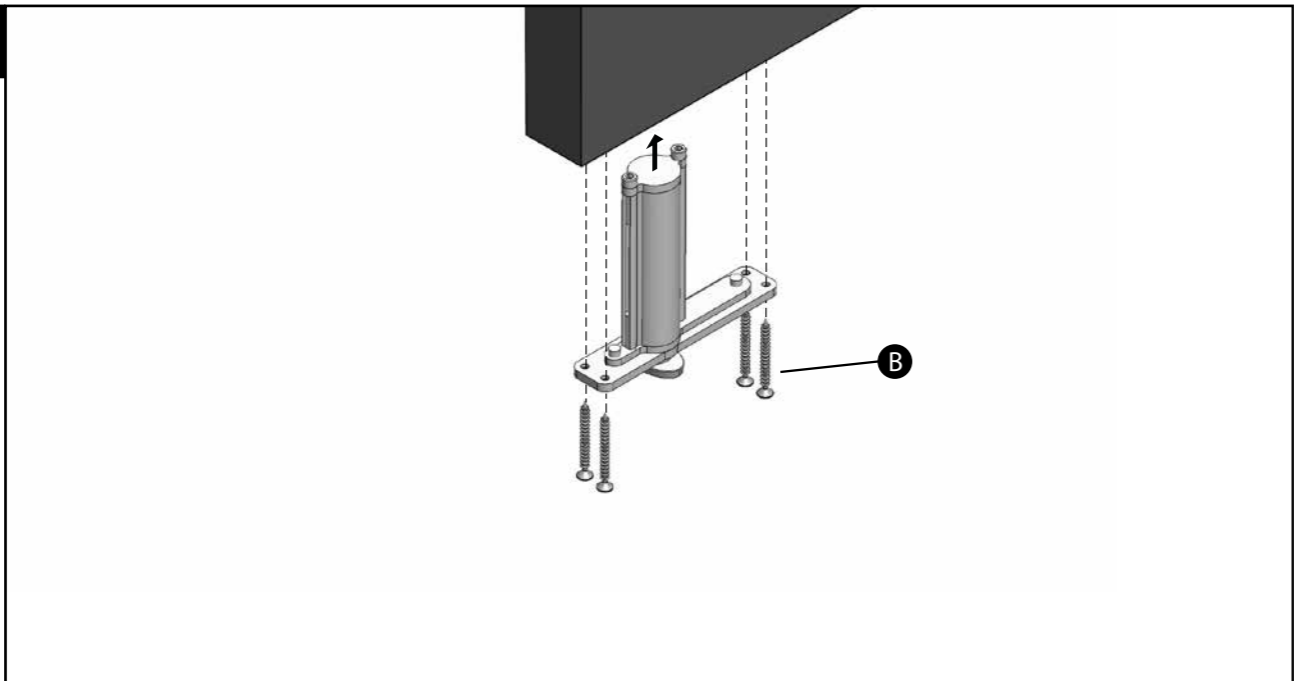

IMAGE FJ14S3

16

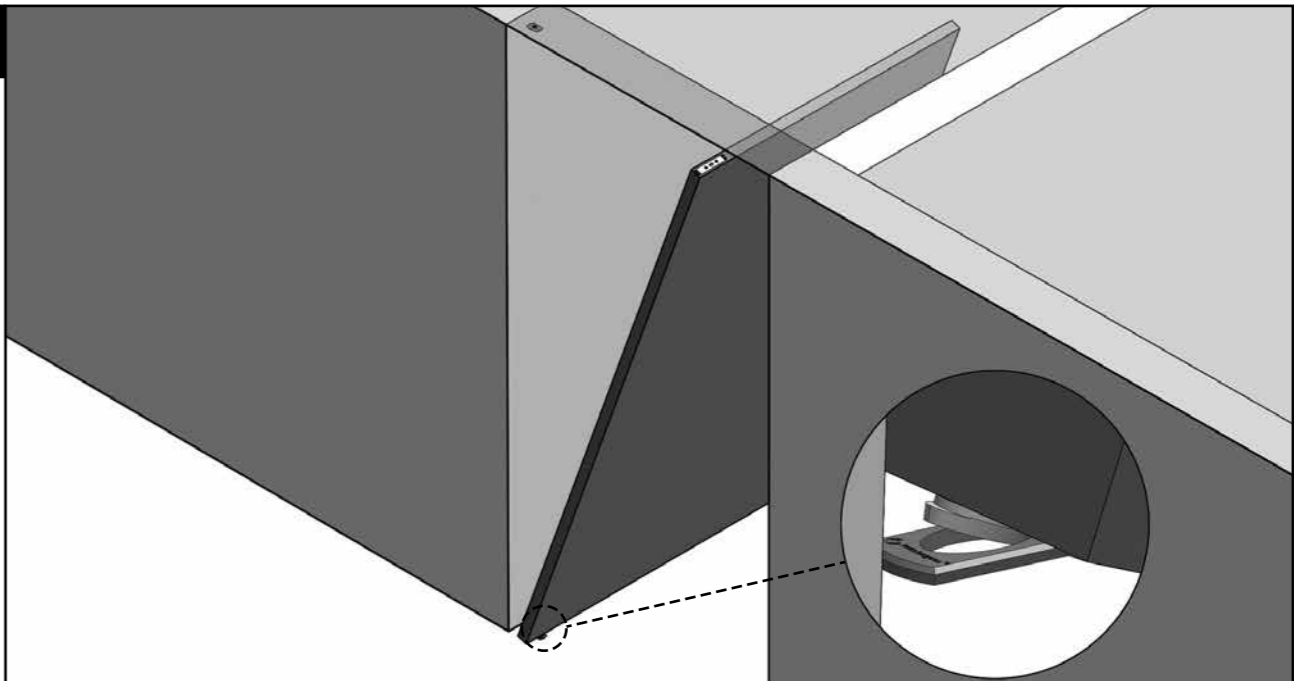

IMAGE FJ16S3



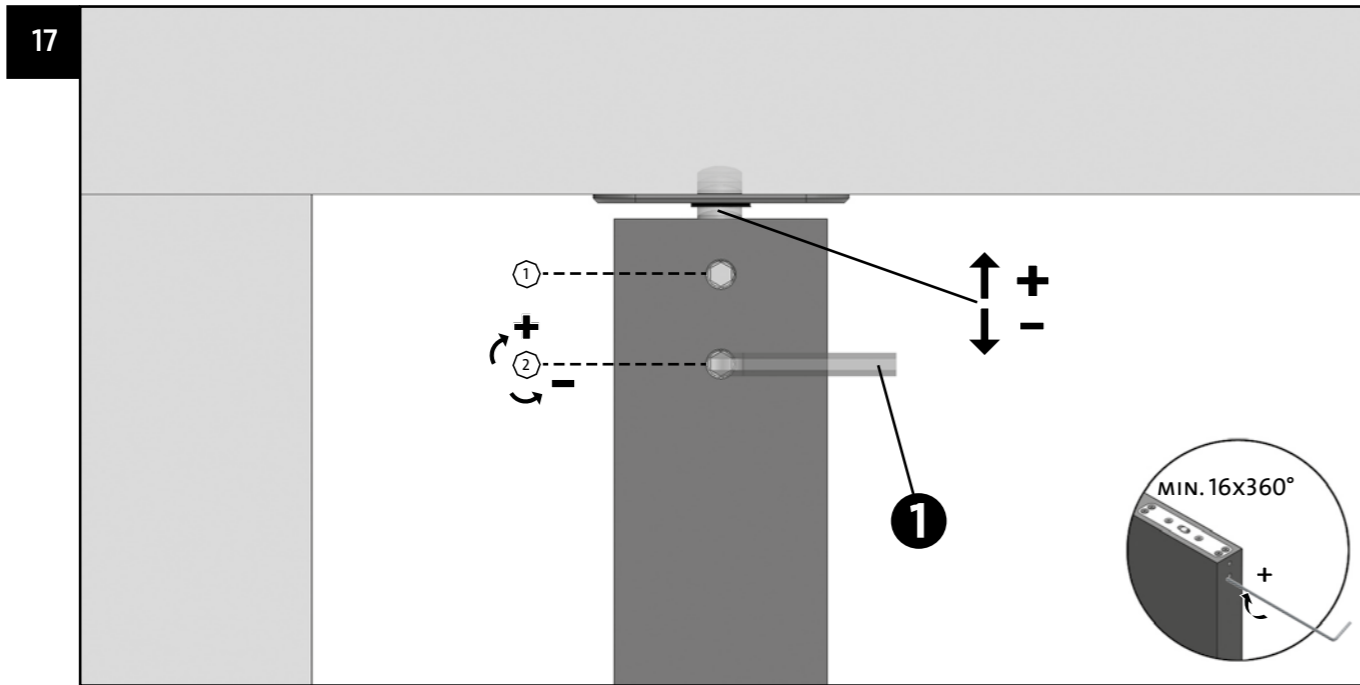

IMAGE FJ17

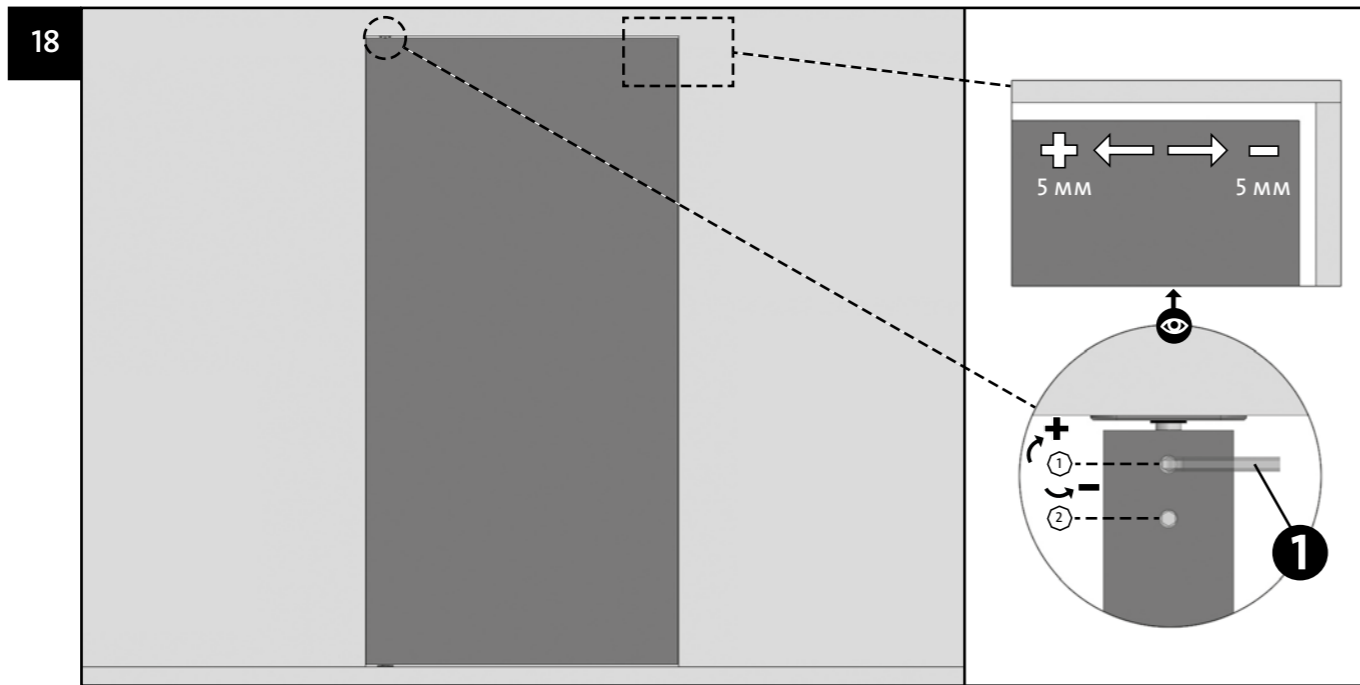

IMAGE FJ18

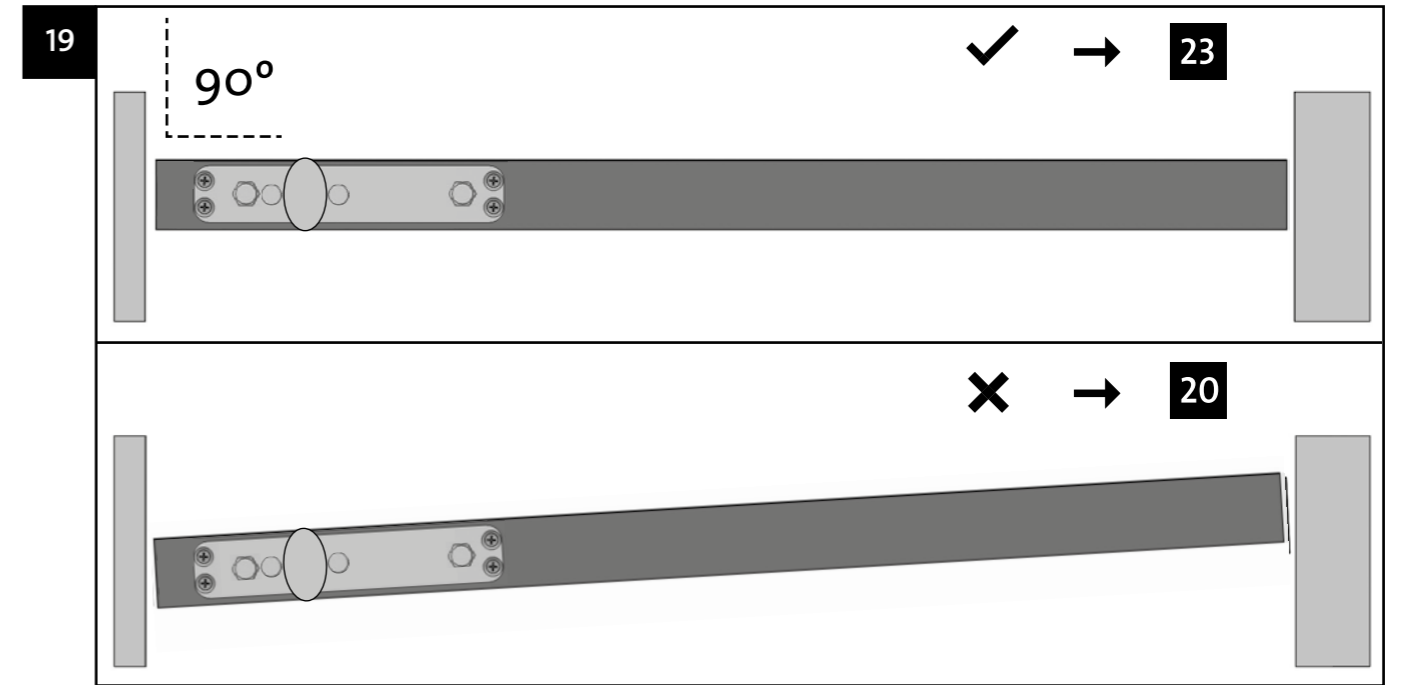

IMAGE FJ19

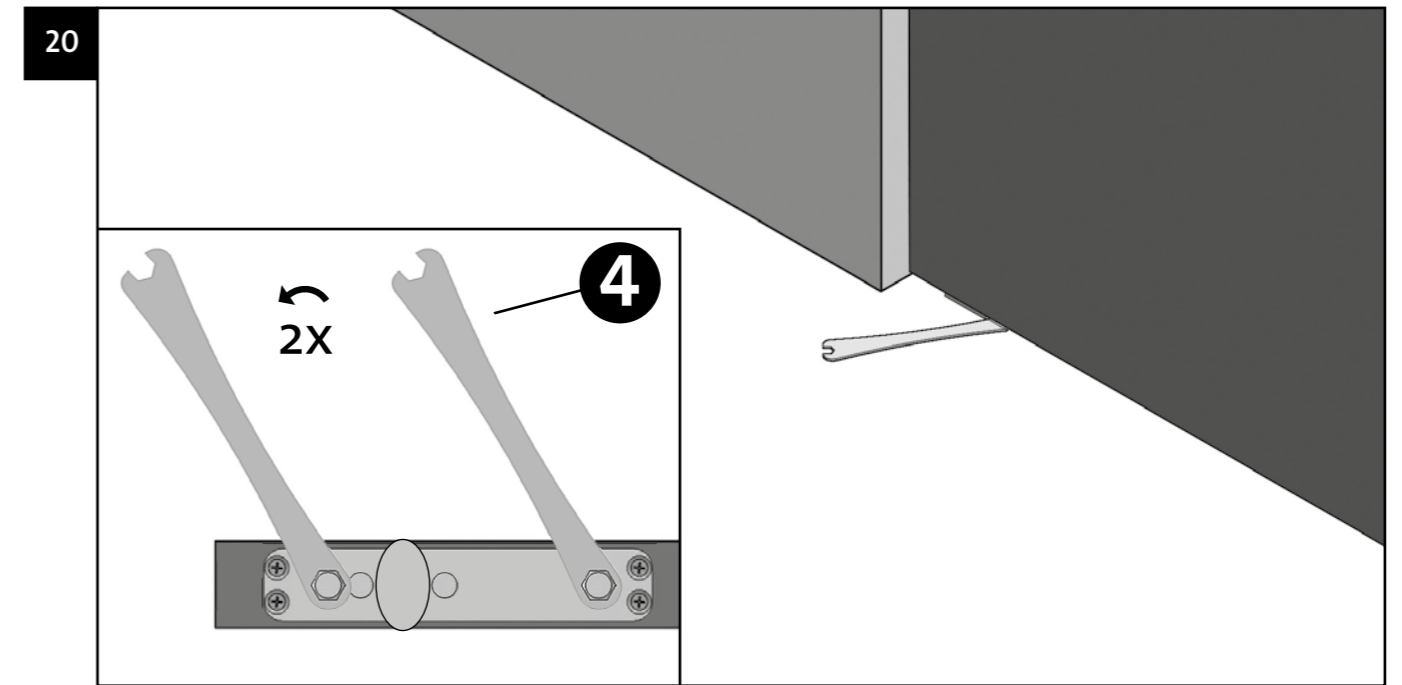

IMAGE FJ20

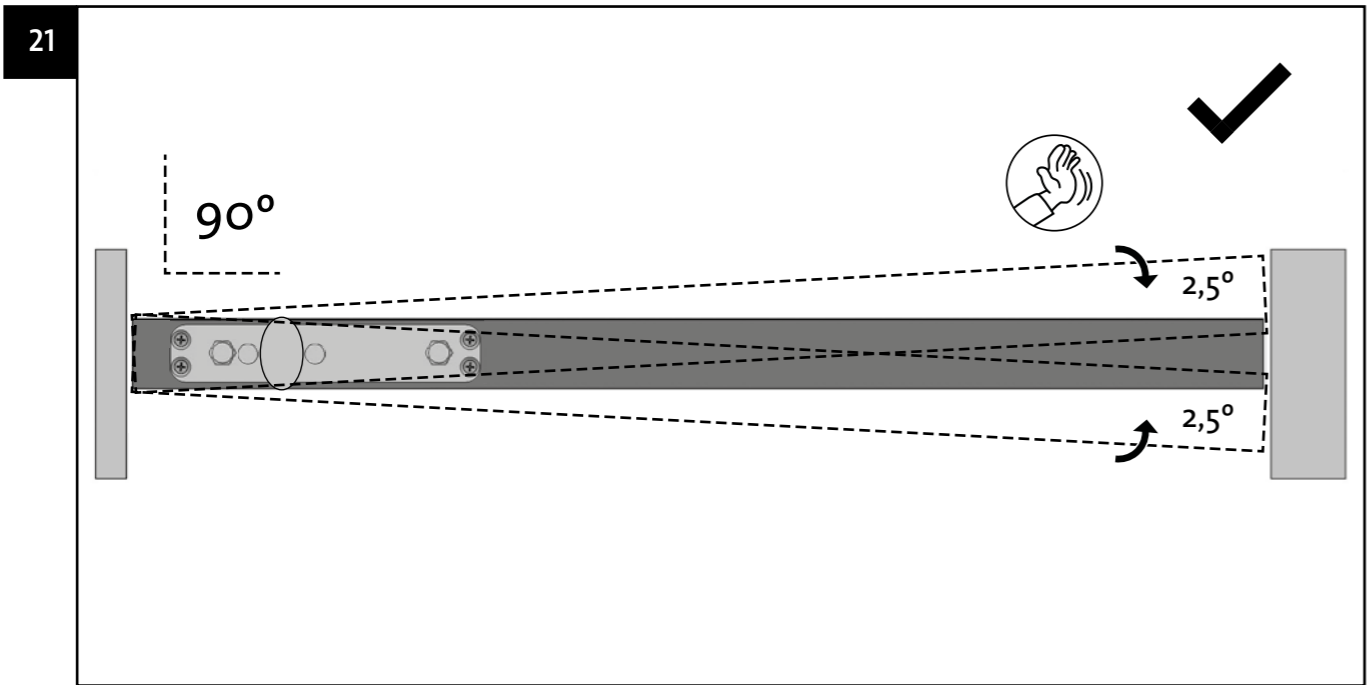

IMAGE FJ21

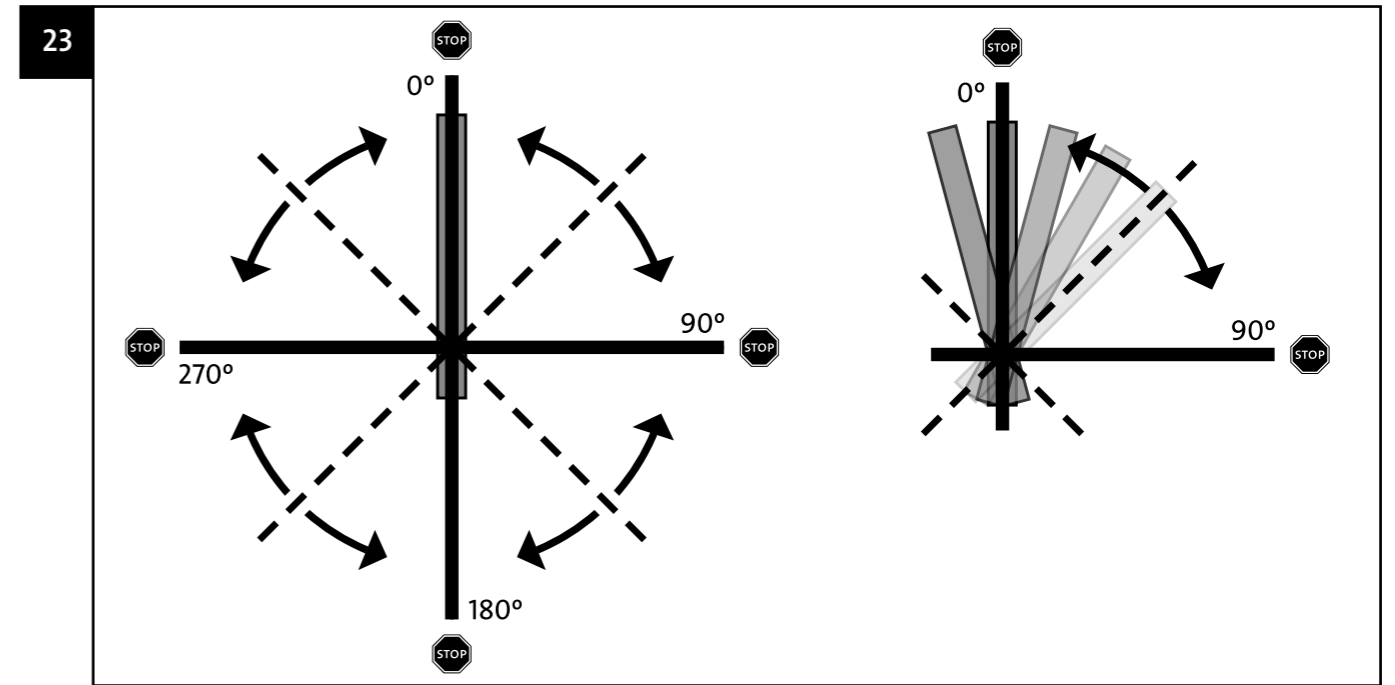

IMAGE FJ24S3

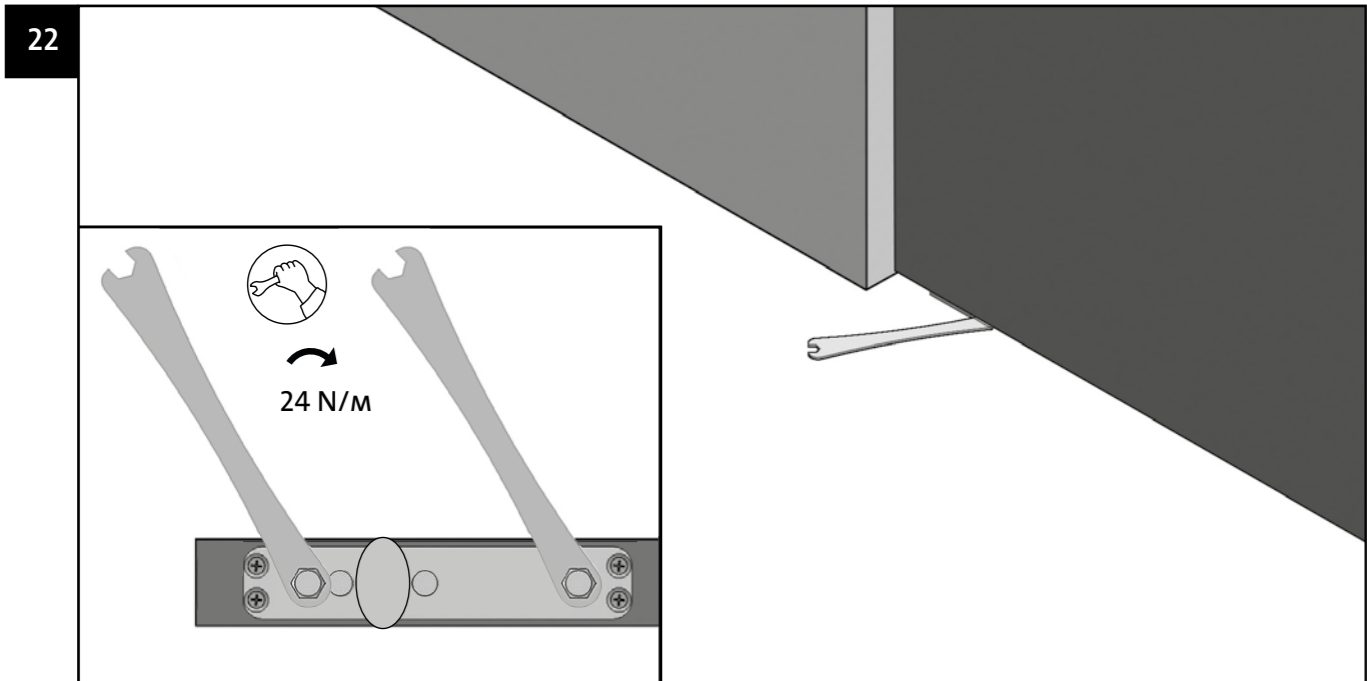

IMAGE FJ22



[www.fritsjurgens.com](http://www.fritsjurgens.com)

